

Expanding your opportunities



eikon[®] e2s

GB Microwave Combination Oven
Installation and User Manual CE – Original, GB

IMPORTANT

Customer documentation

- The customer documentation is part of the microwave combination oven.
- Keep the customer documentation manuals handy at all times so that you can look up any required information.
- Keep the customer documentation manuals for the entire life of the appliance.
- Carefully read the Installation and User Manual before using, handling, and working on this appliance.
- If you transfer the microwave combination oven to a new owner, make sure to give the new owner the customer documentation manuals as well.

Contents

1	General information	5
1.1	EC Declaration of Conformity	6
1.2	Environmental protection	7
1.3	Important Information	7
1.4	Identifying your microwave combination oven	8
1.5	Structure of customer documentation	9
1.6	About this Installation and User Manual	9
2	Design and function	11
2.1	Design and function of the microwave combination oven	12
2.2	Layout and function of the operating panel	13
3	For your safety	14
3.1	Basic safety code	15
3.2	Intended use of your microwave combination oven	20
3.3	Warning signs on your microwave combination oven	21
3.4	Summary of hazards	23
3.5	Hazards and safety precautions when moving the appliance	25
3.6	Hazards and safety precautions when setting up the appliance	26
3.7	Hazards and safety precautions during installing	27
3.8	Hazards and safety precautions when preparing appliance for use	28
3.9	Hazards and safety precautions during operation	29
3.10	Hazards and safety precautions during cleaning	31
3.11	Hazards and safety precautions when taking the appliance out of service	33
3.12	Safety devices	34
3.13	Requirements to be met by personnel and working positions	36
3.14	Personal protective equipment	37
4	Moving the appliance	39
4.1	Working safely with the appliance	40
4.2	Moving the appliance to the installation location	41
5	Setting up the appliance	42
5.1	Safe working when setting up the appliance	43
5.2	Requirements for the installation location	44
5.3	Unpacking the appliance	46
5.4	Taking the appliance off the pallet	48
5.5	Mounting the appliance on a work surface	48
6	Installation	49
6.1	Safe working during electrical installation	50
6.2	Planning the electrical installation	50
6.3	Electrical installation requirements	52
7	Preparing the appliance for use	54
7.1	Safe working when preparing the appliance for use	55
7.2	Procedure for preparing the appliance for use	57

7.3	Main menu screen	59
7.4	The keyboard screen	60
8	Cooking procedures	61
8.1	Operating principles and instructions for cooking	62
8.1.1	Working safely with the appliance	63
8.1.2	Turning the oven on and off	65
8.1.3	How to cook	66
8.2	Operation instructions: Full Serve Mode	68
8.2.1	The Press&Go Menu	69
8.2.2	Using a cooking profile	70
8.2.3	Creating a cooking profile	71
8.2.4	Using a cooking profile	74
8.2.5	Managing cooking profile groups	77
8.2.6	Basic settings of your microwave combination oven	81
8.2.7	Using a USB stick	89
9	Cleaning procedures	91
9.1	Daily cleaning tasks	92
9.2	Cleaning chemicals	92
9.3	Items required for cleaning	93
9.4	Safe working when cleaning	94
9.5	Cleaning procedures	96
9.5.1	Cool down procedure before cleaning	97
9.5.2	Cleaning instructions	99
10	Taking the appliance out of operation and disposal	103
10.1	Safe working when taking the appliance out of operation	105
10.2	Taking the appliance out of operation and disposal	106
11	Technical data	107
11.1	Technical data	108
11.2	Dimensional drawings	110
12	Servicing information	111
12.1	Warranty information and contacting customer service	112
12.2	Rectifying faults: problems in operation	113

1 General information

Purpose of this chapter

This chapter shows you how to identify your microwave combination oven and provides guidance on using this manual.

Contents

This chapter contains the following topics:

	Page
EC Declaration of Conformity	6
Environmental protection	7
Important Information	7
Identifying your microwave combination oven	8
Structure of customer documentation	9
About this Installation and User Manual	9

1.1 EC Declaration of Conformity

Manufacturer

Authorised Representative (Brand Headquarters)

Welbilt UK Limited
Ashbourne House, The Guildway,
Old Portsmouth Road
Guildford GU3 1LR
United Kingdom

Factory

Welbilt UK Limited
Provincial Park, Nether Lane,
Ecclesfield
Sheffield S35 9ZX
United Kingdom

Equipment details

Generic Model Number eikon e2s
Description Commercial Combination Microwave Oven

Declaration of Conformity with directives and standards

The manufacturer hereby declares that this commercial combination microwave oven complies with the following directives and standards.

Compliance with Directives

This commercial combination microwave oven complies with the relevant provisions of the following European Directives:

EMC 2004/108/EC RoHS 2011/65/EU MD 2006/42/EC

Harmonised standards applied

This commercial combination microwave oven complies with the relevant requirements of the following European standards:

EN 60335-2-90:2006 +A1 (excluding Annex EE ship board requirements)

EN 60335-1:2012

EN 62233:2008

EN 55014-2:1997+A2:2008 in accordance with Category IV requirements

- Electrostatic discharge IEC 61000-4-2
- Radiated RF interference IEC 61000-4-3
- Fast transient common mode, AC port IEC 61000-4-4
- Mains surge, AC port IEC 61000-4-5
- RF current, common mode, AC port IEC 61000-4-6
- Mains voltage dips and interruptions IEC 61000-4-11
- Flicker IEC 61000-3-11

EN 55011:2009+A1:2010 Classification: Class A, Group 2

- Mains terminal disturbance voltage Table 6
- Radiated disturbance, magnetic field Table 9
- Radiated disturbance, electric field Table 9

AS/NZS CISPR 11

- Radiated disturbance CISPR 11:2009 Class A
- Conducted disturbance CISPR 11:2009 Class A

Manufacturer

Place and Date of issue: Guildford, 31st July 2015



Mr Philip Radford

Vice President Products: Merrychef
(on behalf of the Authorised Representative)

Quality and environmental management

Welbilt UK Limited (Sheffield) employs a quality management system in accordance with EN ISO 9001:2008 and a certified environmental management system in accordance with EN ISO 14001.

1.2 Environmental protection

Statement of principles

Our customers' expectations, the legal regulations and standards and our company's own reputation set the quality and service for all our products.

We have an environmental management policy that not only ensures compliance with all environmental regulations and laws, but also commits us to continuous improvement of our green credentials.

We have developed a quality and environmental management system in order to guarantee the continued manufacture of high-quality products and to be sure of meeting our environmental targets.

This system satisfies the requirements of ISO 9001:2008 and ISO 14001:2004.

Environmental protection procedures

We observe the following procedures:

- Use of RoHS2-compliant products
- REACH chemical law
- Recycling of electronic waste
- Environmentally friendly disposal of old appliances via the manufacturer

Join us in our commitment to protect the environment.

1.3 Important Information

Users are cautioned that maintenance and repairs should be performed by a Merrychef® authorised service agent using genuine Merrychef® replacement parts. Merrychef® will have no obligation with respect to any product that has been improperly installed, adjusted, operated or not maintained in accordance with national and local codes or installation instructions provided with the product, or any product that has its serial number defaced, obliterated or removed, or which has been modified or repaired using unauthorised parts or by unauthorised service agents. For a list of authorised service agents please refer to your distributor.

1.4 Identifying your microwave combination oven

Position of nameplate

The nameplate is located on the rear of your microwave combination oven.



1 Model number

eikon e2s

2 Elements of the item number

	Label	Meaning
Model	e2s	
Power output convection	D	2200W
	F	2200W / 1300W
	G	2200W / 900W
Power output microwave	B	2000W (High Power version)
	X	1000W (Standard Power version)
Voltage	30	230V
	MV5	220-230V / 50Hz
	MV6	208-240V / 60Hz
	00	200V
	20	220V
Frequency	5	50Hz
	6	60Hz
Lead	A - Z	Example: H = L+N+E (4mm EU)
Plug	A - Z	Example: E = 3-pin plug
Communication	L	USB + LAN
	U	USB
Version	A, B	A, B (pre-production)
	1, 2, ...	1, 2, ... (serial production)
Accessory / Customer	CF	"Trend" exterior
	CL	"Classic" exterior
	WW	Specific customer
Region / Country	EU	Europe
	US	United States of America

3 Elements of the serial number

	Label	Meaning
Year of manufacture	15	2015
	16, ...	2016, ...
Month of manufacture	01	January
	02, ...	February, ...
Place of manufacture	2130	Sheffield (UK)
Production number	12345	

4 Technical data

5 Date of manufacture

1.5 Structure of customer documentation

Contents of customer documentation

The customer documentation for the microwave combination oven includes the following documents:

- Installation and User Manual (this document)

1.6 About this Installation and User Manual

Purpose

This Installation and User Manual is intended for all people who work with the microwave combination oven, and provides them with the necessary information for carrying out installation, operating tasks, cleaning jobs and minor servicing work properly and safely.

Who should read the Installation and User Manual

Name of target group	Tasks
Equipment mover	Conveying within the establishment
Service technician	<ul style="list-style-type: none">▪ Setting up the appliance▪ Preparing the appliance for first-time use and taking the appliance out of service▪ Instructing the user
Owner of the microwave combination oven or Owner's member of staff who is responsible for the appliance	<ul style="list-style-type: none">▪ Made aware of all safety-related functions and devices of the microwave combination oven by the service technician▪ Instructed by the service technician on how to operate the appliance▪ Provides assistance as instructed with conveying the appliance within the establishment and setting up the appliance
User	Essentially performs specific operating tasks such as <ul style="list-style-type: none">▪ Loading the microwave combination oven▪ Starting cooking profiles▪ Removing food▪ Cleaning the microwave combination oven▪ Fitting accessories in the microwave combination oven▪ Minor servicing tasks

Parts of this document that must be read without fail

If you do not follow the information in this document, you risk potentially fatal injury and property damage.

To guarantee safety, all people who work with the microwave combination oven must have read and understood the following parts of this document before starting any work:

- The chapter '*For your safety*' on page 14
- The sections that describe the activity to be carried out

Chapters in the Installation and User Manual

Chapter/section	Purpose
General information	<ul style="list-style-type: none">▪ Shows you how to identify your appliance▪ Provides guidance on using this Installation and User Manual



Chapter/section	Purpose
Design and function	<ul style="list-style-type: none"> Specifies the intended use of the appliance Explains the functions of the appliance and shows the position of its components
For your safety	<ul style="list-style-type: none"> Describes the hazards posed by the appliance and suitable preventive measures It is important that you read this chapter carefully.
Moving the appliance	<ul style="list-style-type: none"> Specifies the basic appliance dimensions Specifies the requirements for the installation position Explains how to convey the appliance to the installation position
Setting up the appliance	<ul style="list-style-type: none"> Explains how to unpack the appliance and specifies the parts supplied with the appliance Explains how to set up the appliance
Installation	Provides information on installing the electrical supply
Preparing the appliance for use	Explains the procedure for preparing the appliance for first-time use
Cooking procedures	<ul style="list-style-type: none"> Explains how to switch on the microwave combination oven Contains the instructions for working procedures during cooking Contains the instructions for handling operations on the microwave combination oven regularly performed during cooking
Cleaning procedures	<ul style="list-style-type: none"> Contains the cleaning instructions Describes the cleaning chemicals Contains and refers to the instructions for handling operations on the microwave combination oven regularly performed during cleaning
Taking the appliance out of operation and disposal	<ul style="list-style-type: none"> Explains the procedure for taking the appliance out of service Contains information on disposal
Technical data	Contains the technical data and dimensional drawings
Servicing information	Contains a catalogue of potential errors and faults and specifies the required actions

Safety alert symbol

Safety alert symbol	Meaning
	Warns of potential injuries. Heed all the warning notices that appear after this symbol to avoid potential injuries or death.

Form of warning notices

The warning notices are categorized according to the following hazard levels:

Hazard level	Consequences	Likelihood
 DANGER	Death / serious injury (irreversible)	Immediate risk
 WARNING	Death / serious injury (irreversible)	Potential risk
 CAUTION	Minor injury (reversible)	Potential risk
NOTICE	Damage to property	Potential risk

Decimal points

Decimal points are used throughout this manual in any language available.

2 Design and function

Purpose of this chapter

This chapter describes the design and construction of the microwave combination oven and explains its functions.

Contents

This chapter contains the following topics:

	Page
Design and function of the microwave combination oven	12
Layout and function of the operating panel	13

2.1 Design and function of the microwave combination oven

Parts and their function

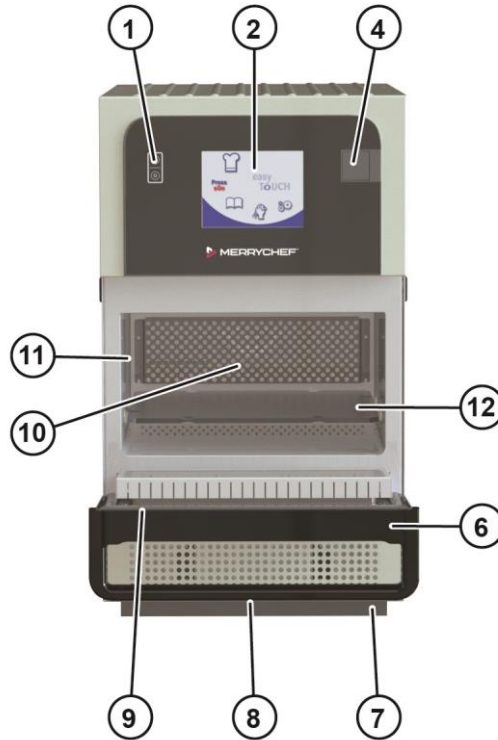

Item	Name	Function
1	ON/OFF appliance switch	Used to turn the microwave combination oven on and off. Turning this switch off does not isolate the appliance from the electricity supply.
2	easyToUCH® screen control panel	When the appliance is switched on the easyToUCH® screen illuminates the user interface. See ' <i>Cooking procedures</i> ' on page 61 for details.
3	Nameplate (no picture)	Located on the rear panel of the appliance, the nameplate states the serial number, model type and electrical specifications.
4	USB port	A USB socket located under the cover allows updates to programs stored on the appliance. See USB MenuConnect® Operating Instructions. See ' <i>Cooking procedures</i> ' on page 61 of this manual, for details of updating cooking profiles.
5	Air outlets (no picture)	Air used to cool internal components and steam from the cavity escape through the air outlet vents located on the rear of the appliance. The air outlets must be kept free from obstruction and they will not allow microwave energy to escape into the environment.
6	Appliance door	The door is a precision-made energy barrier with three microwave safety interlocks. Always keep it clean and do not use it to support heavy objects. See ' <i>Cleaning procedures</i> ' on page 91.
7	Air filter	The air filter situated at the lower front of the appliance is part of the ventilation system. Keep it free of obstruction and clean it daily as described under ' <i>Cleaning procedures</i> ' on page 91. The appliance will not operate without the air filter fitted.

Item	Name	Function
8	Door handle	The door handle is a rigid bar which is pulled downwards and away from the appliance to open it.
9	Door seals	The door seals ensure a tight seal around the door. Always keep them clean and check regularly for signs of damage. At the first sign of wear have them replaced by a Merrychef approved service agent. See ' <i>Cleaning procedures</i> ' on page 91.
10	Air diffuser (not fitted to all appliances)	Keep the air diffuser clean and free of debris. Take great care when cleaning this area of the appliance noting the different requirements shown under ' <i>Cleaning procedures</i> ' on page 91 in this manual.
11	Cavity	The cavity (cooking chamber) is constructed from stainless steel and used for cooking products. Keep it clean by following the cleaning instructions in the ' <i>Cleaning procedures</i> ' on page 91 section of this manual.
12	Cook plate	The cook plate is flat and square with all four sides having circular dips for easily fitting onto the cavity support stubs (Two on each side). Both sides of the cook plate can be used for cooking and all sides are designed to fit onto the cavity support stubs.

Material

The interior and exterior structure of the appliance is made of stainless steel in either a brushed finish or colour-coded.

2.2 Layout and function of the operating panel

Elements and their function

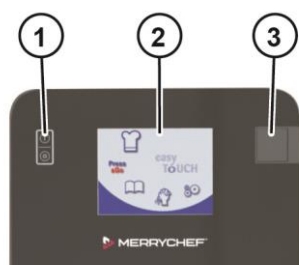

Item	Name	Function
1	ON/OFF appliance switch	Switches the microwave combination oven on and off.
2	Touchscreen	Central controls of the appliance <ul style="list-style-type: none"> ▪ Appliance operated by touching icons on touchscreen pages ▪ Status displays
3	USB port	For connecting a USB memory stick

3 For your safety

Purpose of this chapter

This chapter provides you with all the information you need in order to use the microwave combination oven safely without putting yourself or others at risk.

This is a particularly important chapter that you must read through carefully.

Contents

This chapter contains the following topics:

	Page
Basic safety code	15
Intended use of your microwave combination oven	20
Warning signs on your microwave combination oven	21
Summary of hazards	23
Hazards and safety precautions when moving the appliance	25
Hazards and safety precautions when setting up the appliance	26
Hazards and safety precautions during installing	27
Hazards and safety precautions when preparing appliance for use	28
Hazards and safety precautions during operation	29
Hazards and safety precautions during cleaning	31
Hazards and safety precautions when taking the appliance out of service	33
Safety devices	34
Requirements to be met by personnel and working positions	36
Personal protective equipment	37



3.1 Basic safety code

Object of this safety code

This safety code aims to ensure that all persons who use the microwave combination oven have a thorough knowledge of the hazards and safety precautions, and that they follow the warning notices given in this Installation and User Manual and on the appliance. If you do not follow this safety code, you risk potentially fatal injury and property damage.

Referring to the this Installation and User Manual

Follow the instructions below:

- Read in full the chapter '*For Your Safety*' on page 14 and the chapters that relate to your work.
- Always keep to hand the Installation and User Manual for reference.
- Pass on the Installation and User Manual with the microwave combination oven if it changes ownership.

Personal protective equipment for your personnel

Instruct your personnel to wear the correct personal protective equipment specified in the section '*Personal protective equipment*' on page 37 in the '*For your safety*' chapter for the relevant tasks.

Ground rules for installation

Installation must comply with all national and regional laws and regulations and comply with the local regulations of the relevant utility companies and local authorities and with other relevant requirements.

Working with the microwave combination oven

Follow the instructions below:

- Only those persons who satisfy the requirements stipulated in this Installation and User Manual are permitted to use the microwave combination oven.
- Only use the microwave combination oven for the specified use. Never, under any circumstances, use the microwave combination oven for other purposes.
- Take all the safety precautions specified in this Installation and User Manual and on the microwave combination oven. In particular, use the prescribed personal protective equipment.
- Only stand in the working positions specified.
- Do not make any changes to the microwave combination oven, e. g. removing parts or fitting un-approved parts. In particular, you must not disable any safety devices.

IMPORTANT SAFETY INSTRUCTIONS

When using electrical appliances basic safety precautions should be followed, including the following:

WARNING – To reduce the risk of burns, electric shock, fire, injury to persons, or exposure to excessive microwave energy:

- Read all instructions before using the appliance.
- Install or locate this appliance only in accordance with the provided installation instructions.

Restrictions on use

- Only use utensils that are suitable for use in microwave combination ovens. See 'Procedure for preparing the appliance for use'.
- Do not use corrosive chemicals or vapors in this appliance. This type of oven is specifically designed to heat, cook or toast food. It is not designed for industrial or laboratory use.
- Never use the appliance to heat alcohol, e. g. brandy, rum, etc. Food containing alcohol can more easily catch fire if overheated. Observe caution and do not leave the appliance unattended.
- Never attempt to deep fry in the oven.
- Eggs in their shell and whole hard boiled eggs should not be heated in microwave ovens since they may explode even after microwave heating has ended.
- Do not operate the appliance using microwave only or combination function without food or liquid inside the cooking chamber as this may result in overheating and may cause damage.
- The appliance should not be used to dry linen.
- **WARNING:** Liquids and other foods must not be heated in completely sealed containers as the build-up of steam may cause them to explode.
- Do not attempt to operate the appliance with: an object caught in the door, door that does not close properly; a damaged door, hinge, latch, sealing surface or without food in the oven.

Precautions when using the microwave combination oven

- **WARNING:** Microwave heating of beverages can result in delayed eruptive boiling. Therefore care must be taken when handling the container.
- When handling hot liquids, foods and containers, care should be taken to avoid scalds and burns.
- As with any cooking appliance, care should be taken to avoid combustion of the items within the appliance.

Instructions for safe use of the microwave combination oven

- When heating liquids using microwave only or combination function, the contents should be stirred prior to heating to help prevent eruptive boiling.
- **WARNING:** The contents of feeding bottles and baby food jars must be stirred or shaken and the temperature checked before consumption, in order to avoid burns.
- Items should be unwrapped when using convection and combination functions.
- Excess fat should be removed during 'roasting' and before lifting heavy containers from the oven.
- Food with a skin, e. g. potatoes, apples, sausages, etc. should be pierced before heating.
- When heating food in plastic or paper containers, keep an eye on the oven due to the possibility of ignition.
- Food in combustible plastic or paper containers should be transferred to a microwave/oven proof container to avoid the possibility of ignition.
- In the event of glass breaking or shattering within the oven, ensure that food is totally free of glass particles. If in doubt, dispose of any food that was in the oven at the time of the breakage.
- Switch off the appliance at the end of all the cooking sessions for that day.

Requirements to be met by operating personnel

- This appliance is not intended for use by persons (including children) with reduced physical sensory or mental capabilities or lack of experience and knowledge unless they have been given supervision or instruction concerning use of the appliance in a safe way and understand the hazards involved. Children shall not play with the appliance. Cleaning and user maintenance shall not be made by children.
- **WARNING:** It is hazardous for anyone other than a competent person to carry out any service or repair operation that involves the removal of any cover which gives protection against exposure to microwave energy. See '*Requirements to be met by personnel, working positions*' on page 36.

Requirements relating to the operating condition of the microwave combination oven

- As with all electrical appliances, it is recommended to have the electrical connections inspected at least once a year.
- This appliance must be grounded. Connect only to a properly grounded outlet. See '*Planning the electrical installation*' on page 50.
- Never remove the external covers of the appliance.
- Never remove any fixed internal parts of the appliance.

- Never tamper with the control panel, door, seals, or any other part of the appliance.
- Never hang dish towels or cloths on any part of the appliance.
- **WARNING:** If the door or door seal is damaged, the appliance must not be operated until it has been repaired by a competent person. See '*Requirements to be met by personnel, working positions*' on page 36.
- The appliance must not be operated without the air filter in place.
- If the supply cord is damaged, it must be replaced by the manufacturer, its service agent or similarly qualified persons in order to avoid a hazard.

Requirements relating to the operating environment of the microwave combination oven

- The minimum height of free space necessary above the top surface of the appliance is 50mm (2").
- The floor adjacent to the appliance may be slippery. Clean up spillages immediately.
- This appliance is not intended for mobile use, such as in marine or vehicle applications.

Cleaning requirements

- The appliance should be cleaned regularly and any food deposits removed.
- The cooking chamber of the appliance and the door seals should be cleaned frequently. Failure to maintain the appliance in a clean condition could lead to deterioration of the surface that could adversely affect the life of the appliance and possibly result in a hazardous situation.
- The appliance should not be cleaned with a water jet.
- Details for cleaning door seals, cavities and adjacent parts are provided in the '*Cleaning procedures*' section of this manual.
- The appliance must be disconnected from its power supply during maintenance and when replacing parts. It is not necessary to disconnect the appliance from the power supply during routine daily cleaning tasks.
- When cleaning surfaces of door and oven that come together on closing the door see the instructions on cleaning the door surface in the '*Cleaning procedures*' on page 91 section of this manual.

Emergency instructions

- If smoke is observed: switch off the appliance. Unplug or isolate it from the electrical supply and keep the door closed in order to stifle any flames.

SAVE THESE INSTRUCTIONS

More on this ...

Related topics

▷ Summary of hazards	23
▷ Hazards and safety precautions during operation	29
▷ Hazards and safety precautions during cleaning	31
▷ Hazards and safety precautions when moving the appliance	25
▷ Hazards and safety precautions when setting up the appliance	26
▷ Hazards and safety precautions during installing	27
▷ Hazards and safety precautions when preparing appliance for use	28
▷ Hazards and safety precautions when taking the appliance out of service	33
▷ Safety devices	34
▷ Requirements to be met by personnel and working positions	36
▷ Personal protective equipment	37



3.2 Intended use of your microwave combination oven

Intended use of your microwave combination oven

The microwave combination oven must only be used for the purposes specified below:

- The microwave combination oven is designed and built solely for cooking different foodstuffs in containers approved by the manufacturer. Microwave, convection and impingement are used for this purpose.
- The microwave combination oven is intended solely for professional, commercial use.

Restrictions on use

Some materials are not allowed to be heated in the microwave combination oven:

- No dry powder or granulated material
- No highly flammable objects with a flash point below 270°C / 518°F, such as highly flammable oils, fats or cloths (kitchen cloths)
- No food in sealed tins or jars

Requirements to be met by personnel

- The microwave combination oven must only be operated and installed by personnel who satisfy specific requirements. Please refer to '*Requirements to be met by personnel, working positions*' on page 36 for the training and qualifications requirements.
- Personnel must be aware of the risks and regulations associated with handling heavy loads.

Requirements relating to the operating condition of the microwave combination oven

- Do not operate the microwave combination oven unless it has been properly transported, set up, installed and placed into operation as indicated in this manual and the person responsible for placing it into operation has confirmed this.
- The microwave combination oven must only be operated when all safety devices and protective equipment are fitted, in working order and fixed properly in place.
- The manufacturer's regulations for operation and servicing of the microwave combination oven must be observed.

Requirements relating to the operating environment of the microwave combination oven

Specified operating environment for the microwave combination oven:

- The ambient temperature lies between +4°C / 40°F and +35°C / 95°F
- Not a toxic or potentially explosive atmosphere
- Dry kitchen floor to reduce the risk of accidents

Specified properties of the installation location:

- No fire alarm, no sprinkler system directly above the appliance
- No flammable materials, gases or liquids above, on, under or in the vicinity of the appliance
- It must be possible to set up the microwave combination oven in the installation position so that it cannot tip over or slide about. The supporting surface must comply with these requirements.

Mandatory restrictions on use:

- The appliance must not be operated outdoors and not be shifted or moved during use.

Cleaning requirements

- Use only cleaning chemicals that have been approved by the manufacturer.
- High-pressure cleaners or water jets must not be used for cleaning.
- The appliance must not be treated with alkali or acid solutions or exposed to acid fumes.

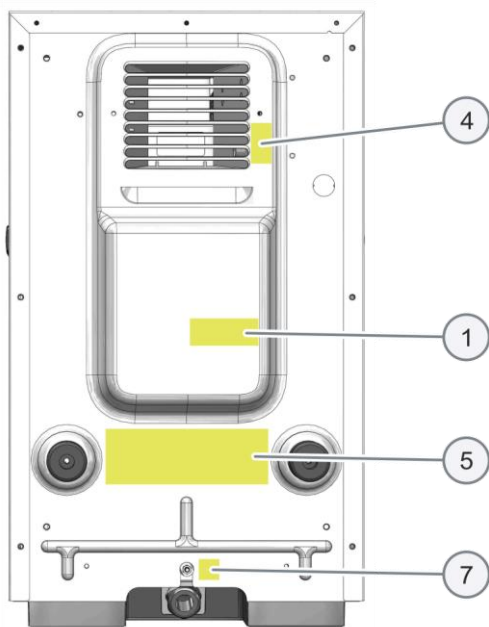
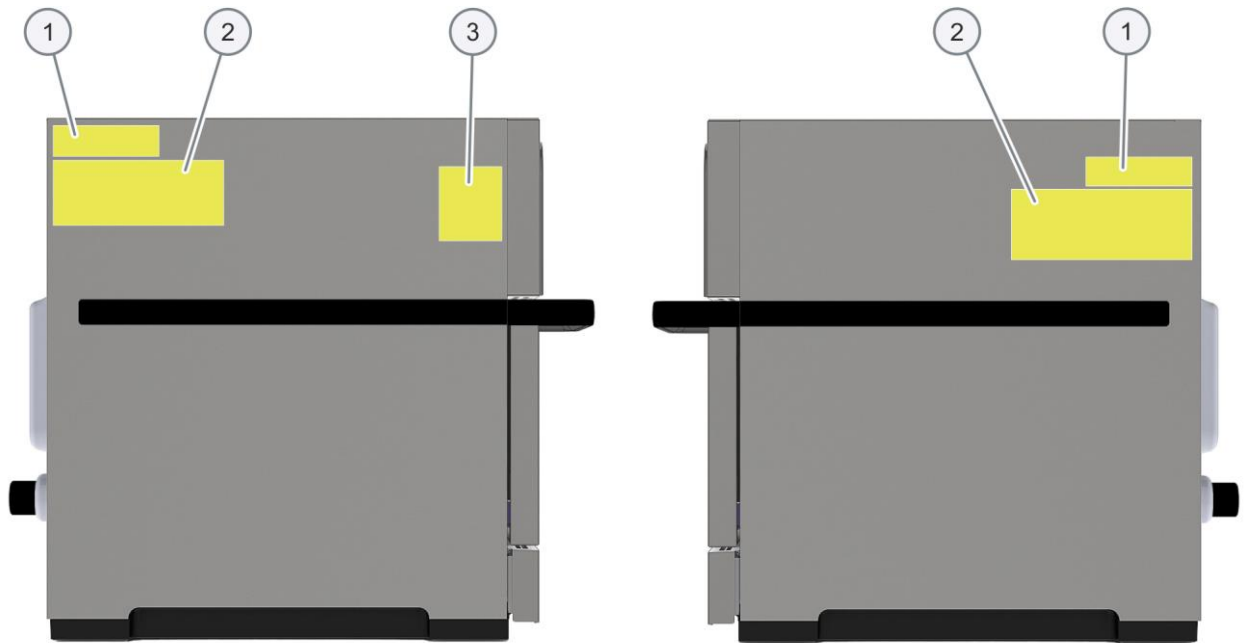

3.3 Warning signs on your microwave combination oven

Warning and safety signs





Mandatory warning signs

The following warning signs / notices must be attached to the microwave combination oven and optional accessories in the area indicated so as to be easily visible at all times.

Area	Warning sign	Description
1		Microwaves warning There is a risk of external and internal burns of body parts following exposure to microwave energy.
2		Electric shock warning There is a risk of electric shock if the appliance is serviced without disconnecting the electrical supply.
3		Fire / electric shock warning There is a risk of fire / electric shock if the appliance is operated without respecting the minimum clearances.
4		Hot surface warning There is a risk of burns from high temperatures inside the cavity and on the inside of the appliance door.
5		Electric shock warning There is a risk of electric shock if the electrical power is not connected to a properly grounded outlet.

Safety symbols

The following safety symbols be attached to the microwave combination oven in the area indicated so as to be easily visible at all times.

Area	Safety symbol	Description
6		Protective Earth (Ground)
7		Equipotential bonding

3.4 Summary of hazards

General rules for dealing with hazards and safety precautions

The microwave combination oven is designed to protect the user from all hazards that can reasonably be avoided by design measures.

The actual purpose of the microwave combination oven, however, means that there are still residual risks; you must therefore take precautions to avoid them. A safety device can provide you with a certain degree of protection against some of these hazards. You must ensure, however, that these safety devices are in place and in working order.

The nature of these residual risks and what effect they have are described below.

Hazard points

The following illustration shows a Merrychef e2s microwave combination oven:

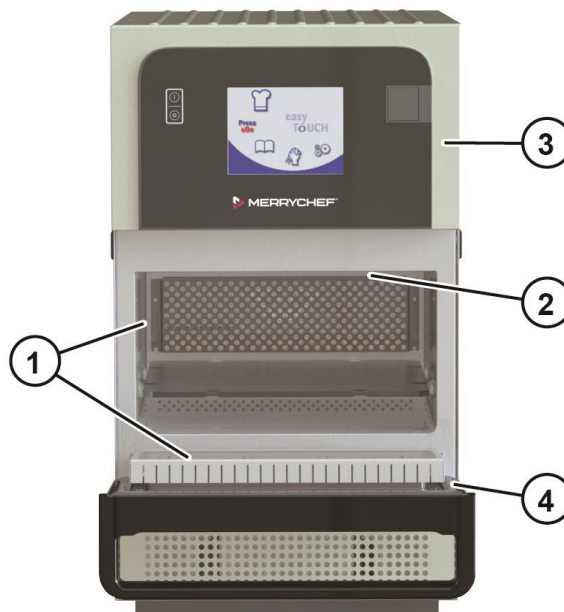

Excessive microwave energy

The microwave combination oven generates microwave energy. An operation with an open or damaged door or cavity can result in external and internal burns of body parts following exposure to microwave energy.

Heat generation (1)

The microwave combination oven becomes hot inside the cavity and on the inside of the appliance door. This poses a risk of burns on hot surfaces inside the microwave combination oven, and also on hot appliance parts, food containers and other accessories used for cooking.

Hot steam / vapour (2)

When cooking food the microwave combination oven may generate hot steam and vapour which escapes when the appliance door is opened and which is removed through the air vents on the rear of the microwave combination oven when the appliance door is closed. This poses a risk of scalding from hot steam when the appliance door is opened. Take particular care when opening the appliance door if the top door edge is below your field of vision.

Hot liquids

Foodstuffs are cooked in the microwave combination oven. These foodstuffs may also be liquid, or liquefy during cooking. This poses a risk of scalding from hot liquids, which may be spilled if not handled properly.

Live components (3)

The microwave combination oven contains live parts. This means a risk from live parts if the cover is not in place.

Contact with cleaning chemicals

The microwave combination oven must be cleaned using special cleaning chemicals. This poses a risk from cleaning chemicals, some of which can cause skin burns.

Parts moving against each other (4)

For various actions, such as opening/shutting the appliance door or cleaning the appliance door, there is the risk that you will crush or cut your hand.

Undercooking of food products

Ensure all food is hot before serving to protect your guests from microbiological contamination of foodstuffs.



3.5 Hazards and safety precautions when moving the appliance

Safety hazard: moving heavy weights

Danger	Where or in what situations does the hazard arise?	Preventive action
Risk of injury from over-stressing your body	When moving the appliance onto and off the moving equipment	<ul style="list-style-type: none"> ▪ Use a forklift truck or pallet truck ▪ Do not exceed safety limits for lifting and carrying ▪ Wear personal protective equipment

Safety hazard: mechanical parts of the appliance

Danger	Where or in what situations does the hazard arise?	Preventive action
Risk of body parts being crushed if the appliance is dropped	When moving the appliance	<ul style="list-style-type: none"> ▪ Use suitable handling gear ▪ Move the appliance slowly and carefully, and secure it against tipping over ▪ Make sure center of gravity is balanced ▪ Avoid jolts
Risk of body parts being crushed if the appliance tips over or falls off	When placing the appliance down on the supporting surface	Always observe the requirements for the supporting surface while setting up the appliance; see ' <i>Requirements for the installation location</i> ' on page 44

3.6 Hazards and safety precautions when setting up the appliance

Safety hazard: moving heavy weights

Danger	Where or in what situations does the hazard arise?	Preventive action
Risk of injury from over-stressing your body	When moving the appliance	<ul style="list-style-type: none"> ▪ Use a forklift truck or pallet truck to place the appliance in the installation position or to move it to a new position ▪ Always use the correct number of persons and observe the limits specified for lifting and carrying when adjusting the appliance position ▪ Observe the local occupational safety regulations ▪ Wear personal protective equipment

Safety hazard: mechanical parts of the appliance

Danger	Where or in what situations does the hazard arise?	Preventive action
Risk of body parts being crushed if the appliance is dropped	When lifting the appliance	<ul style="list-style-type: none"> ▪ Make sure center of gravity is balanced ▪ Avoid jolts
Risk of cuts from sharp edges	When handling sheet-metal parts	<ul style="list-style-type: none"> ▪ Exercise caution when performing these tasks ▪ Wear personal protective equipment



3.7 Hazards and safety precautions during installing

Safety hazard: electrical power

Danger	Where or in what situations does the hazard arise?	Preventive action
Risk of electric shock from live parts	<ul style="list-style-type: none"> ▪ Under covers ▪ Under the operating panel ▪ Along the mains power lead 	<ul style="list-style-type: none"> ▪ Work on the electrical system must only be performed by qualified electricians from an authorised service company ▪ Professional working <p>Ensure that all electrical connections are in perfect condition and fixed securely before putting the appliance into use</p>
	On the appliance and on adjacent metal parts	Before preparing the appliance for use, make sure that the appliance is connected to an equipotential bonding system (EU).

Safety hazard: mechanical parts of the appliance

Danger	Where or in what situations does the hazard arise?	Preventive action
Trapping fingers or body	When opening or closing the door	Use the handle and avoid the door hinges



3.8 Hazards and safety precautions when preparing appliance for use

Safety hazard: electrical power

Danger	Where or in what situations does the hazard arise?	Preventive action
Risk of electric shock from live parts	<ul style="list-style-type: none"> ▪ Under covers ▪ Under the operating panel ▪ Along the mains power lead 	<ul style="list-style-type: none"> ▪ Work on the electrical system must only be performed by qualified electricians from an authorised service company ▪ Professional working
	On the appliance and on adjacent metal parts	Ensure that all electrical connections are in perfect condition and fixed securely before putting the appliance into use
		Before preparing the appliance for use, make sure that the appliance is connected to an equipotential bonding system (EU).

Additional safety hazards when preparing appliance for use

When preparing the appliance for use, read and follow the safety information given in this chapter and also the following sections in the chapter '*For your safety*' on page 14 in this Installation and User Manual:

- 'Hazards and safety precautions during operation'
- 'Hazards and safety precautions during cleaning'

3.9 Hazards and safety precautions during operation

Safety hazard: microwave energy

Danger	Where or in what situations does the hazard arise?	Preventive action
A risk of burns from excessive microwave energy	If the door, the door seal or the cavity of the appliance are damaged persons standing in front of the appliance can be harmed by leaking microwave energy.	<ul style="list-style-type: none"> ▪ Do not attempt to operate this oven with the door open since open-door operation can result in harmful exposure to microwave energy. It is important not to defeat or tamper with the safety interlocks. ▪ Do not place any object between the oven front face and the appliance door or allow soil or cleaner residue to accumulate on sealing surfaces. ▪ Do not operate the oven if it is damaged. It is particularly important that the oven door closes properly and that there is no damage to the (1) door (bent), (2) hinges, (3) door seals and sealing surfaces. ▪ The oven should not be adjusted or repaired by anyone except properly qualified service personnel.

Safety hazard: heat – hot surfaces

Danger	Where or in what situations does the hazard arise?	Preventive action
A risk of burns from hot surfaces	Inside the entire cavity, including all parts that are or were inside during cooking, such as <ul style="list-style-type: none"> ▪ Racks ▪ Containers, baking sheets, shelf grills etc. On the inside of the appliance door	Wear specified protective clothing, in particular protective gloves

Safety hazard: heat – hot liquid

Danger	Where or in what situations does the hazard arise?	Preventive action
Risk of scalding from hot liquid	<ul style="list-style-type: none"> ▪ Inside the cavity ▪ Outside the appliance 	<ul style="list-style-type: none"> ▪ Only load containers holding liquid or liquefying food into the cavity that allow a proper view inside the container, and always hold horizontally when removing ▪ Wear specified protective clothing, in particular protective gloves

Safety hazard: contamination of foodstuffs

Danger	Where or in what situations does the hazard arise?	Preventive action
Risk from microbiological contamination of food	When cooking is manually interrupted	<ul style="list-style-type: none"> ▪ Never deliberately interrupt the cooking process ▪ Do not store food temporarily in the appliance
	When cooking is interrupted because of a power failure	Once the appliance is running again, consider how the length of time taken to resume operation will affect the food condition.

Safety hazard: moving appliances supported on a wheeled base

Danger	Where or in what situations does the hazard arise?	Preventive action
Risk of crushing of body parts Risk of hands and feet being pinched Risk of scalding from hot liquid food Risk of electric shock from live parts	While appliances are being moved on a wheeled platform	<ul style="list-style-type: none"> ▪ Only move appliances forward for the purpose of cleaning the case of the microwave combination oven or the floor under the appliances. ▪ Disconnect the appliance from the electrical supply before moving it ▪ When operating the appliances, always engage the parking brake on the wheels ▪ Check that wheel brakes are on before operation each day

Safety hazard: electrical power

Danger	Where or in what situations does the hazard arise?	Preventive action
Risk of electric shock from live parts	If appliances on wheeled stands start moving unintentionally and the power supply is pulled off	<ul style="list-style-type: none"> ▪ When operating the appliances, always engage the parking brake on the wheels ▪ Check that wheel brakes are on before operation each day

Safety hazard: mechanical parts of the appliance

Danger	Where or in what situations does the hazard arise?	Preventive action
Risk of slipping from escaping condensate	In front of the appliance	Ensure that the floor around the appliance is dry at all times

3.10 Hazards and safety precautions during cleaning

Safety hazard: cleaning chemicals

Danger	Where or in what situations does the hazard arise?	Preventive action
Risk of chemical burns or irritation to skin, eyes and respiratory system from contact with cleaning chemicals and their fumes	For all cleaning actions	<ul style="list-style-type: none"> ▪ Do not let cleaning chemicals come into contact with your skin or eyes ▪ Do not heat up the appliance if there are cleaning chemicals inside ▪ Never spray cleaning chemicals into the cavity ▪ Do not breathe in spray ▪ Wear personal protective equipment
	When corrosive cleaning chemicals are used	Only use those cleaning chemicals specified under ' <i>Cleaning agents</i> ' on page 92.

Safety hazard: contamination of foodstuffs

Danger	Where or in what situations does the hazard arise?	Preventive action
Risk of food contamination from cleaning chemicals	If the cavity has not been washed off properly after cleaning.	Wash off the cavity using a clean cloth and plenty of clean warm water, then wipe with a soft cloth or paper towel.

Safety hazard: heat

Danger	Where or in what situations does the hazard arise?	Preventive action
A risk of burns from hot surfaces	Inside the entire cavity, including all parts that are or were inside during cooking, such as <ul style="list-style-type: none"> ▪ Racks ▪ Containers, baking sheets, shelf grills etc. 	<ul style="list-style-type: none"> ▪ Before starting cleaning tasks, wait until the cavity has cooled to below 50°C / 122°F or use the 'cool down' function to cool the cavity ▪ Wear specified protective clothing, in particular protective gloves
	On the inside of the appliance door	
Risk of scalding from hot steam if water is sprayed into the hot cavity	In the entire cavity	<ul style="list-style-type: none"> ▪ Before starting cleaning work, wait until the cavity has cooled to below 50°C / 122°F or use the 'Cool Down' function to cool the cavity ▪ Wear specified protective clothing, in particular protective gloves
Risk of scalding from hot steam	In front of the appliance if the cavity is being cooled by the 'Cool Down' function	<ul style="list-style-type: none"> ▪ Step back from the appliance to avoid the hot steam and vapour escaping through the open appliance door ▪ Do not put your head inside the cavity

Safety hazard: moving appliances supported on a wheeled base

Danger	Where or in what situations does the hazard arise?	Preventive action
All specified hazards	While appliances are being moved on a wheeled platform	When moving the microwave combination oven, take care not to wheel over the electrical supply cables
Risk of crushing of body parts	While appliances are being moved on a wheeled platform	Watch out for the connecting cables
Risk of scalding from hot liquid food	While appliances are being moved on a wheeled platform	Always remove any food from the appliance before moving it
Risk of electric shock from live parts	While appliances are being moved on a wheeled platform	Watch out for connected electrical cables
Risk of tripping from exposed cables	While cleaning behind appliances when pulled forward	Exercise caution when performing this action

Safety hazard: electrical power

Danger	Where or in what situations does the hazard arise?	Preventive action
Risk of electric shock caused by a short-circuit	If the appliance comes into contact with water	<ul style="list-style-type: none"> ▪ Do not wash down the outer case with water ▪ Always keep the USB cover closed during cleaning
Risk of electric shock from live parts	If appliances on wheeled stands start moving unintentionally and the power supply is pulled off	<ul style="list-style-type: none"> ▪ When operating the appliances, always engage the parking brake on the wheels ▪ Check that wheel brakes are on before operation each day

Safety hazard: mechanical parts of the appliance

Danger	Where or in what situations does the hazard arise?	Preventive action
Risk of crushing to hands and pinching of fingers	When opening and closing the appliance door	Exercise caution when performing this action

3.11 Hazards and safety precautions when taking the appliance out of service

Safety hazard: electrical power

Danger	Where or in what situations does the hazard arise?	Preventive action
Risk of electric shock from live parts	<ul style="list-style-type: none"> ▪ Under covers ▪ Under the operating panel 	<ul style="list-style-type: none"> ▪ Work on the electrical system must only be performed by qualified electricians from an authorized customer service company ▪ Professional working

Safety hazard: moving heavy weights

Danger	Where or in what situations does the hazard arise?	Preventive action
Risk of injury from over-stressing your body	When moving the appliance onto and off the moving equipment	<ul style="list-style-type: none"> ▪ Use a forklift truck or pallet truck ▪ Do not exceed safety limits for lifting and carrying ▪ Wear personal protective equipment

Safety hazard: mechanical parts of the appliance

Danger	Where or in what situations does the hazard arise?	Preventive action
Risk of body parts being crushed if the appliance tips over or falls off	When the appliance is being moved e.g. to gain better access to the connections	Always observe the requirements for the supporting surface when taking the appliance out of service; see ' <i>Requirements for the installation site</i> ' on page 44
Risk of slipping on damp kitchen floor	In front of the appliance	Ensure that the floor around the appliance is dry at all times

3.12 Safety devices

Meaning

The microwave combination oven has a number of safety devices to protect the user from hazards. It is absolutely essential that all safety devices are fitted and in working order when operating the appliance.

Position and function

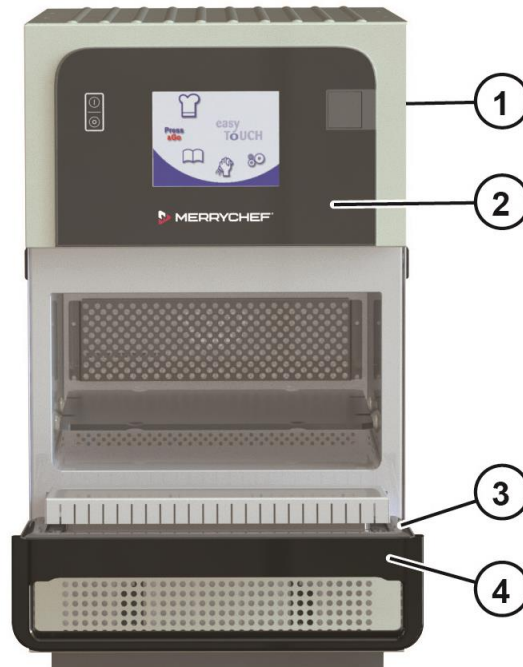

Item	Safety device	Function	Check
1	Covers can only be removed using a tool	<ul style="list-style-type: none"> Prevents live parts from being touched accidentally Prevents access to the moving fan from the wiring compartment 	Check that the covers are in place
2	Operating panel can only be removed using a tool	Prevents live parts from being touched accidentally	Ensure that the operating panel is in place
3	Door seal	Protects the user and outside environment from microwave energy leaking from the cavity	Check the door seal regularly for signs of damage and replace it if required.
4	Appliance door	Protects the user and outside environment from hot steam and microwave energy	Check the door regularly for damage and replace it if required
5 (no picture)	Door interlocks: Electric door sensor for appliance door	Ensures that the microwave generation system cannot be powered when the door is open.	Check door switch: Action: <ul style="list-style-type: none"> Open the appliance door fully Press Start Result: Door open warning message

Item	Safety device	Function	Check
6 (no picture, installed by customer)	Disconnection device	<ul style="list-style-type: none">▪ Installed by the customer close to the appliance; easily visible and accessible, 1- or 3-pole action, minimum contact separation 3 mm.▪ Used to disconnect the appliance from the power supply during cleaning, repair and servicing work and in case of danger	Action: <ul style="list-style-type: none">▪ Trip the disconnection device
7 (no picture)	Internal fuses	Prevent faulty components from drawing too much current and causing potential fire hazard.	Ensure that the internal fuses are correctly rated

3.13 Requirements to be met by personnel and working positions

Requirements to be met by operating personnel

Personnel	Qualifications	Tasks
Chef	<ul style="list-style-type: none"> ▪ Has relevant professional training ▪ Knows relevant national food legislation and regulations, plus hygiene legislation and regulations ▪ Must keep records in accordance with HACCP ▪ Trained in how to operate the microwave combination oven 	<p>Essentially performs organizational tasks such as</p> <ul style="list-style-type: none"> ▪ Entering the cooking profile data ▪ Editing existing cooking profiles in the cookbook ▪ Developing new cooking profiles ▪ Adjusting appliance settings <p>May also perform all user tasks if applicable.</p>
User	<ul style="list-style-type: none"> ▪ Semi-skilled ▪ Trained in how to operate the microwave combination oven ▪ Works under supervision ▪ Knows the regulations associated with handling heavy loads 	<p>Essentially performs specific operating tasks such as</p> <ul style="list-style-type: none"> ▪ Loading the microwave combination oven ▪ Starting a cooking profile ▪ Removing food ▪ Cleaning the microwave combination oven ▪ Fitting accessories in the microwave combination oven ▪ Minor servicing tasks
Equipment mover	<ul style="list-style-type: none"> ▪ Trained in the use of a pallet truck and forklift truck ▪ Knows the regulations associated with handling heavy loads 	Conveying within the establishment
Service technician	<ul style="list-style-type: none"> ▪ Is an authorised service agent ▪ Has relevant technical training ▪ Is trained in the particular appliance ▪ Knows the regulations associated with handling heavy loads 	<ul style="list-style-type: none"> ▪ Setting up the appliance ▪ Preparing the appliance for first-time use and taking the appliance out of service ▪ Instructing the user

Working positions

- The working position for personnel installing and preparing the appliance for first-time use is the entire appliance area.
- The working position for personnel when operating the appliance is in front of the appliance door.
- The working position for staff during cleaning and servicing is the entire appliance area.



3.14 Personal protective equipment

Moving and setting up the appliance

Activity	Materials used	Personal protective equipment
<ul style="list-style-type: none"> ▪ Conveying within the establishment ▪ Setting up the appliance on a work surface, stand or in a stacking kit ▪ Setting up the appliance in the installation location 	<ul style="list-style-type: none"> ▪ Suitable lifting gear ▪ Forklift truck or pallet truck 	<ul style="list-style-type: none"> ▪ Protective gloves ▪ Safety boots ▪ Hard hat (e.g. when heavy loads are being lifted, working overhead, ...)

Installation, preparing for first-time use and taking out of service

Activity	Materials used	Personal protective equipment
Installing and removing (taking out of operation) the electrical connection	Tools and equipment depending on the task	Work wear and personal protective equipment depending on the job that needs doing as specified in national regulations
<ul style="list-style-type: none"> ▪ Preparing the appliance for first-time use ▪ Instructing the user 	Tools and equipment depending on the task	Work wear as specified in country-specific standards and directives for kitchen work, in particular: <ul style="list-style-type: none"> ▪ Protective clothing ▪ Heat protective gloves (compliant with EN 407 in European Union) ▪ Safety boots
Dismantling the appliance (taking out of operation)	<ul style="list-style-type: none"> ▪ Suitable lifting gear ▪ Forklift truck or pallet truck 	<ul style="list-style-type: none"> ▪ Protective gloves ▪ Safety boots ▪ Hard hat (e.g. when heavy loads are being lifted, working overhead)

Operation

Activity	Materials used	Personal protective equipment
Loading / removing food	None	Work wear as specified in country-specific standards and directives for kitchen work, in particular: <ul style="list-style-type: none"> ▪ Protective clothing ▪ Heat protective gloves (compliant with EN 407 in European Union) ▪ Safety boots
Removing and fitting parts	Tools and equipment depend on the task	Work wear as specified in country-specific standards and directives for kitchen work, in particular: <ul style="list-style-type: none"> ▪ Protective clothing ▪ Heat protective gloves (compliant with EN 407 in European Union) ▪ Safety boots

Cleaning

Activity	Materials used	Personal protective equipment
<ul style="list-style-type: none"> ▪ Cleaning the cavity by hand ▪ Handling spray bottles 	<ul style="list-style-type: none"> ▪ Cleaning chemicals approved by the manufacturer ▪ Protective chemicals approved by the manufacturer 	<p>Items of protection equipment, depending on cleaning chemical being used:</p> <ul style="list-style-type: none"> ▪ Breathing mask ▪ Safety goggles ▪ Protective gloves ▪ Protective clothing/apron <p>The EC safety datasheet for the relevant cleaning chemical contains a more precise specification of these items. An up-to-date copy can be obtained from the manufacturer.</p> <p>Refer to the label on the cleaning chemical concerned.</p>
<p>Cleaning components and accessories according to relevant instructions</p>	<p>Common household detergent: mild on skin, alkali-free, pH-neutral and odourless</p>	<p>Follow the instructions given by the manufacturer of the cleaning chemical you are using</p>
<p>Cleaning the outside of the appliance case</p>	<p>Common household stainless steel cleaner or hard surface cleaner</p>	<p>Follow the instructions given by the manufacturer of the cleaning chemical you are using</p>

4 Moving the appliance

Purpose of this chapter

This chapter provides information on how to move the appliance.

This chapter is intended for the owner's member of staff responsible for the appliance and for a qualified member of staff from an authorized service company.

Contents

This chapter contains the following topics:

	Page
Working safely with the appliance	40
Moving the appliance to the installation location	41



4.1 Working safely with the appliance

For your safety

Before starting work, familiarize yourself with the hazards described in '*Hazards and safety precautions when moving the appliance*' on page 25.

Eligibility of personnel for moving the appliance

Personnel eligible for moving the appliance:

- Only personnel who are trained in the use of a pallet truck and fork-lift truck for handling purposes are permitted to move the appliance.
- Personnel must be aware of the regulations relating to handling heavy loads.

Personal protective equipment

Wear the following personal protective equipment specified in the section '*Personal protective equipment*' on page 37 of the '*For your safety*' chapter for the relevant tasks.

Moving heavy loads

⚠ WARNING

Risk of injury from lifting incorrectly

When lifting the appliance, the weight of the appliance may lead to injuries, especially in the area of the torso.

- ▷ Use a fork-lift truck/pallet truck to move the appliance.
- ▷ When lifting the appliance, use enough people for the weight of the appliance (value depending on age and gender). Observe the local occupational safety regulations.
- ▷ Wear personal protective equipment.

Unsuitable supporting surface

⚠ WARNING

Risk of crushing if the appliance tips over or falls off

Body parts can be crushed if the appliance tips over or falls off.

- ▷ Make sure that the appliance is never placed on an unsuitable supporting surface.

4.2 Moving the appliance to the installation location

Space required for conveying the appliance

Make sure that there is enough width and height along the entire route used for conveying the appliance to ensure it can get through to its installation location.

The table below shows the dimensions of the **appliance including packaging**, which are needed to determine the minimum doorway dimensions required to allow the appliance to be brought to its installation location:

Minimum door opening

Width	[in]	21.1	[mm]	535
Height	[in]	33.5	[mm]	850
Depth	[in]	35.3	[mm]	895

Load bearing capability for conveying the appliance

Provide moving equipment that is rated capable of carrying the load.

Refer to the weight of the appliances including packaging to determine the minimum working load limit of handling equipment; see '*Dimensions and weights*' on page 108.

Moving the appliance to the installation location

Please observe the following points when conveying the appliance:

- Always move the appliance on a pallet.
- Always move the appliance in an upright position.
- Move the appliance slowly and carefully, and secure it against tipping over.
- Make sure that you do not knock against things with the appliance.
- Avoid moving the appliance along uneven routes or up or down slopes/steps.
- Do not lift the oven by the handle but always use the hand lifting points.

5 Setting up the appliance

Purpose of this chapter

This chapter provides information on how to set up your appliance.

This chapter is intended for the user and for a qualified member of staff from an authorized service company.

Contents

This chapter contains the following topics:

	Page
Safe working when setting up the appliance	43
Requirements for the installation location	44
Unpacking the appliance	46
Taking the appliance off the pallet	48
Mounting the appliance on a work surface	48



5.1 Safe working when setting up the appliance

For your safety

Before starting work, familiarize yourself with the hazards described in '*Hazards and safety precautions when setting up the appliance*' on page 26.

Eligibility of personnel for setting up the appliance

Personnel eligible for setting up the appliance:

- Only qualified personnel from an authorized service company are permitted to set up the appliance.

Regulations for setting up the appliance

Local and national standards and regulations relating to workplaces in catering kitchens must be observed.

The rules and regulations of the local authorities and supply companies that apply to the installation location concerned must be observed.

Personal protective equipment

Wear the following personal protective equipment specified in the section '*Personal protective equipment*' on page 37 of the '*For your safety*' chapter for the relevant tasks.

Moving heavy loads

⚠ WARNING

Risk of injury from lifting incorrectly

When lifting the appliance, the weight of the appliance may lead to injuries, especially in the area of the torso.

- ▷ Use a forklift truck or pallet truck to place the appliance in the installation position or to move it to a new position.
- ▷ When shifting the appliance into the correct position, use enough people for the weight of the appliance when lifting it (value depending on age and gender). Observe the local occupational safety regulations.
- ▷ Wear personal protective equipment.

Unsuitable supporting surface

⚠ WARNING

Risk of crushing if the appliance tips over or falls off

Body parts can be crushed if the appliance tips over or falls off.

- ▷ Make sure that the appliance is never placed on an unsuitable supporting surface.

5.2 Requirements for the installation location

Meaning

This section contains information to help you choose a suitable installation location for the microwave combination oven. Inspect the intended installation location carefully to ensure it is suitable before taking the appliance there and starting the installation.

Rules for setting up the appliance safely

To prevent hazards that arise from the installation site and environment of the appliances, the following rules must be observed:

- It must be possible to comply with the operating conditions. For operating conditions, see '*Requirements relating to the operating environment of the microwave combination oven*' on page 20.
- There is a risk of fire from the heat emitted from hot surfaces. Therefore flammable materials, gases or liquids must not be located near, on or below the appliance. When choosing where to install the appliance it is essential to remember this requirement together with the minimum space required for the appliance.
- Heat sources in the vicinity must lie at a minimum distance of 500 mm / 20 in.
- The appliance must be installed so that there is absolutely no possibility that liquid from the appliance or liquid coming from cooking processes can reach deep-fat fryers or appliances that use hot, uncovered fat. Deep-fat fryers or appliances that use hot, uncovered fat that are located in the vicinity must lie at a minimum distance of 500 mm / 20 in.
- The appliance must not be installed directly under a fire alarm or sprinkler system. Fire alarm installations and sprinkler systems must be set up to handle the level of steam and vapour expected to escape from the appliance when the door is opened.
- It must be possible to set up the supporting structure for the appliance (work surface, stand or stacking kit) in the installation position so that it cannot tip over or slide about. The supporting surface must satisfy the requirements listed below.
- Vibrations must generally be avoided when using wheeled oven stands or wheeled stacking kits.

Requirements for the supporting surface

The supporting surface must have the following properties:

- The supporting surface must be flat and level.
- The supporting surface must be able to bear the in-use weight of the appliance plus the weight of the structure supporting the appliance.
- The structure supporting the appliance (work surface or stand) must be able to bear the in-use weight of the appliance.

Empty weight of appliance

e2s High Power version	[lbs]	134	[kg]	61.0
e2s Standard Power version	[lbs]	114	[kg]	51.7

Actual space requirements

Far more room than the specified minimum space requirement is needed in front of the appliances to operate the microwave combination ovens safely, in particular to handle hot food safely.

Larger wall gaps are generally recommended to provide access for servicing.

In the installation location, the following parts must not be covered, adjusted or blocked (see also '*Design and function of the microwave combination oven*' on page 12):

- Air vent on the rear of the appliance
- Air filter at the front of the appliance

Minimum space required

The following diagram and table show the space required for the appliance for different installation and operating situations. They also show the minimum horizontal distances from adjacent walls and surfaces. The safety clearance on the top must always be complied with.

Meaning		Space required			
A	Safety clearance from the top	[in]	2	[mm]	50
B	Depth requirement, appliance door open at 90°	[in]	12.2	[mm]	310
	Safety clearance on left-/right-hand side / at rear	[in]	0	[mm]	0

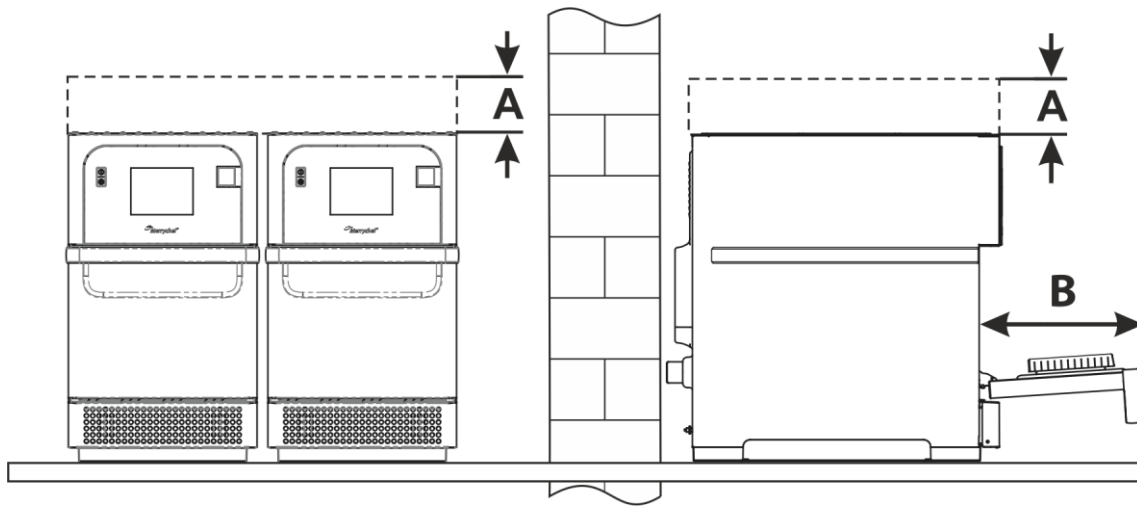

5.3 Unpacking the appliance

1.

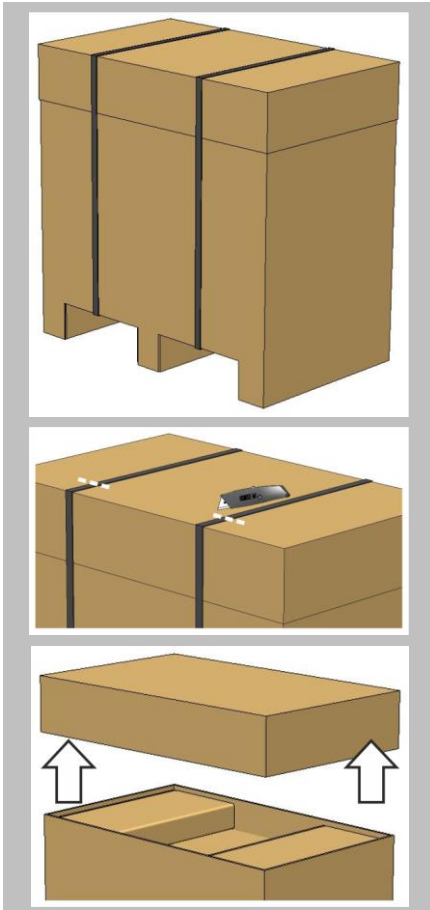

Cut the box banding straps. Remove the lid.

2.

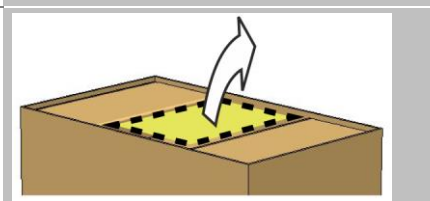

Remove the customer documentation and any product accessories.

3.

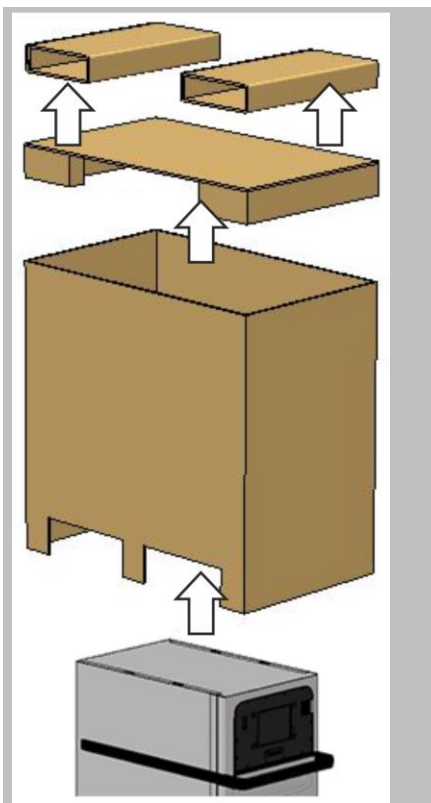

Remove the packaging.

4.

Inspect the appliance for damage before signing the delivery note. Record any damage on the delivery note and notify the carrier and manufacturer.

5.

WARNING
Never install or put into service a damaged appliance under any circumstances.

Contents

- The following parts are supplied:
- 1x Microwave Combination Oven
 - 1x air filter
 - 1x solid cook plate / wire rack
 - 1x paddle
 - 1x cool down pan
 - 1x Installation and User Manual

5.4 Taking the appliance off the pallet

The weight of your appliance is given in the 'Technical Data' on page 107.

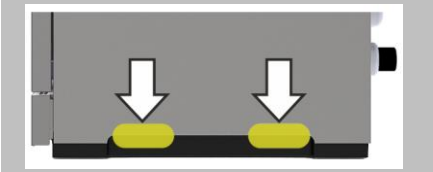
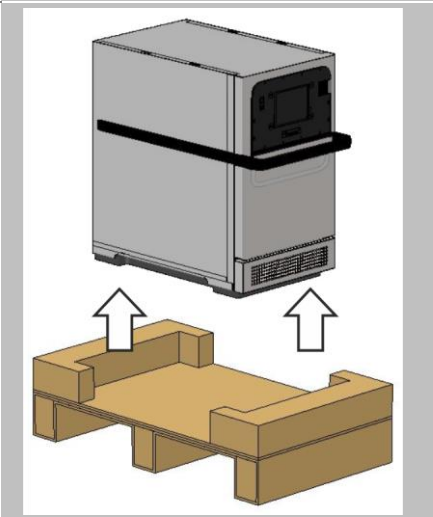
1.  Identify appropriate lifting points.
2.  Lift the appliance from packaging.
Wear appropriate Personal Protective Equipment.
3. **WARNING**

 - Don't lift the oven from the handle.
 - Risk of crushing from the appliance tipping over.

5.5 Mounting the appliance on a work surface

Rules for setting up the appliance safely

Observe the following rules to ensure that the appliance is installed in a stable situation:

- It must be possible to set up the work surface in the installation position so that it cannot tip over or slide about. The supporting surface must comply with the requirements.
- The work top must have a non-slip surface.

6 Installation

Purpose of this chapter

This chapter explains how to connect your microwave combination oven to the electrical supply.

Contents

This chapter contains the following topics:

	Page
Safe working during electrical installation	50
Planning the electrical installation	50
Electrical installation requirements	52

6.1 Safe working during electrical installation

For your safety

Before starting work, familiarize yourself with the hazards described in '*Hazards and safety precautions during installation*' on page 27.

Eligibility of personnel for the electrical installation

Only electricians qualified under the terms of EN 50110-1 and from an authorized service company are permitted to perform work on electrical equipment.

Regulations for the electrical installation

Observe the following requirement to prevent hazards caused by faulty electrical connections:

- The electrical supply must be connected in accordance with applicable local and national regulations and regulations of the professional associations and of the relevant power supply company.

Personal protective equipment

Wear the personal protective equipment specified in the section '*Personal protective equipment*' on page 37 of the '*For your safety*' chapter for the relevant tasks.

Live components

⚠ DANGER

Risk of electric shock from live parts

When the appliance is not connected to an equipotential bonding system, there is a risk of electric shock from touching live parts.

- ▷ Make sure that any work on the electrical system is performed solely by a qualified electrician from an authorized service company.
- ▷ Make sure that the electrical connections are intact and connected securely before putting the appliance into use.
- ▷ Before preparing the appliance for use, make sure that the appliance, including all metallic accessories, is connected to an equipotential bonding system.

6.2 Planning the electrical installation

Meaning

It is crucial to the safe and reliable operation of the appliance that the electrical system is installed carefully and correctly. All the rules and regulations listed here, and the described procedure, must be strictly followed.

⚠ Rules for safe electrical installation of the appliances

Observe the following rules to prevent hazards caused by faulty electrical connections:

- The electrical supply must be connected in accordance with applicable local regulations of the professional associations and of the relevant power supply company.
- The case of the appliance must be grounded in a suitable manner and connected to an equipotential bonding system.
- If two microwave combination ovens are installed in a stacking kit, both cases of the appliances and the stacking kit itself must be grounded in a suitable manner and connected to an equipotential bonding system.

- For microwave combination ovens on a wheeled platform, the length of the mains power lead must accommodate the degree of movement allowed to the appliance by the retaining device on the wheeled platform. When moving the assembly (platform plus appliance), never place the mains power lead under tension.
- All electrical connections must be checked when the appliance is prepared for first-time use to ensure cables are laid correctly and connections are made properly.

Equipment provided by customer and electrical installation regulations

The table below shows what equipment must be provided by the customer and what regulations must be observed when connecting the appliance.

Equipment	Regulations
Fuse	Fuse protection and connection of the appliance must comply with local regulations and national installation requirements.
Equipotential bonding	The appliance must be incorporated in an equipotential bonding system. Equipotential bonding: electrical connection that ensures that the frames of electrical equipment and any external conductive components are at an equal (or practically equal) potential.
Residual-current device (RCD)	The installation regulations require protection by a residual-current device (RCD). Suitable residual-current devices meeting the relevant national regulations must be used. If the installation includes more than one appliance, one residual-current device must be provided for each appliance.
Disconnection device	An easily accessible all-pole disconnection device with a minimum contact separation of 3 mm must be installed close to the appliance. The appliance must be connected via this disconnection device. The disconnection device is used to disconnect the appliance from the electrical supply for cleaning, repair and installation work.

Fitted frequency-converter

The appliance is fitted with one frequency converter (FC) and an EMC mains input filter.

These devices may result in a leakage current of more than 3.5 mA per FC drive.

Use a suitable RCD for the rated voltage.

Properties of the residual-current device

The residual-current device (RCD) must have the following properties:

- Filter for filtering out RF currents
- "Time delayed" trip characteristic for RCD devices with trip threshold >30mA: prevents RCD being tripped by charging currents of capacitors and parasitic capacitances when appliance is switched on.
- "Leakage current protection, type SI" trip characteristic for RCD devices with trip threshold ≥ 30 mA: insensitive to nuisance tripping.

6.3 Electrical installation requirements

Circuit Breakers

Establishments with standard (Type 'B') circuit breakers are sensitive to 'surges' which occur on switching on freezers, refrigerators and other catering equipment, including microwave combination ovens. Because of this, a Type 'D' circuit breaker (designed specifically for this type of equipment) must be fitted. An individual, suitably rated circuit breaker should be fitted for each appliance installed.

Low impedance electrical supply

This commercial combination microwave oven complies with EN 61000-3-11. However, when connecting sensitive equipment to the same supply as the appliance, the user should determine in consultation with the supply authority, if necessary, that a low impedance supply is used.

Electrical supply

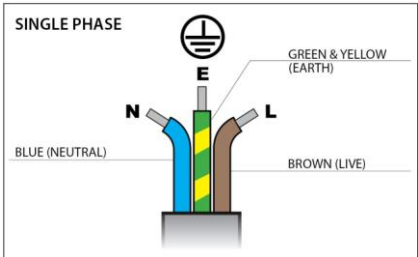
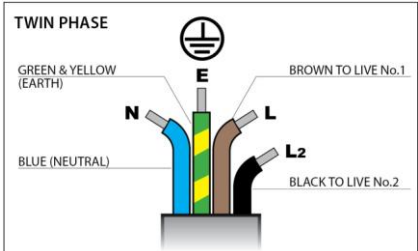
Illustration	Meaning
	<p>UK models are fitted with a blue 32 A plug to IEC 60309 (EN 60309).</p> <p>The circuit breakers should be rated at 32 A for 32 A and 16 A for 16 A plug configurations and be Time Delay, Motor Start Type (European Type D).</p> <p>UK 13 A models are fitted with a moulded plug to BS1363, fused at 13A.</p> <p>EU 16 A models are fitted with a moulded plug to CEE 7/7 (Type F Schuko) rated at 16 A.</p>
	<p>Twin Phase models should be connected as shown.</p> <p>Circuit Breakers should be rated at 20 A or higher per phase and be Time Delay, Motor Start Type (European Type D).</p>

Equipotential bonding



An Equipotential Bonding point is provided on the rear panel of the appliance for independent Earth (GND) connection.

Phase loading diagram

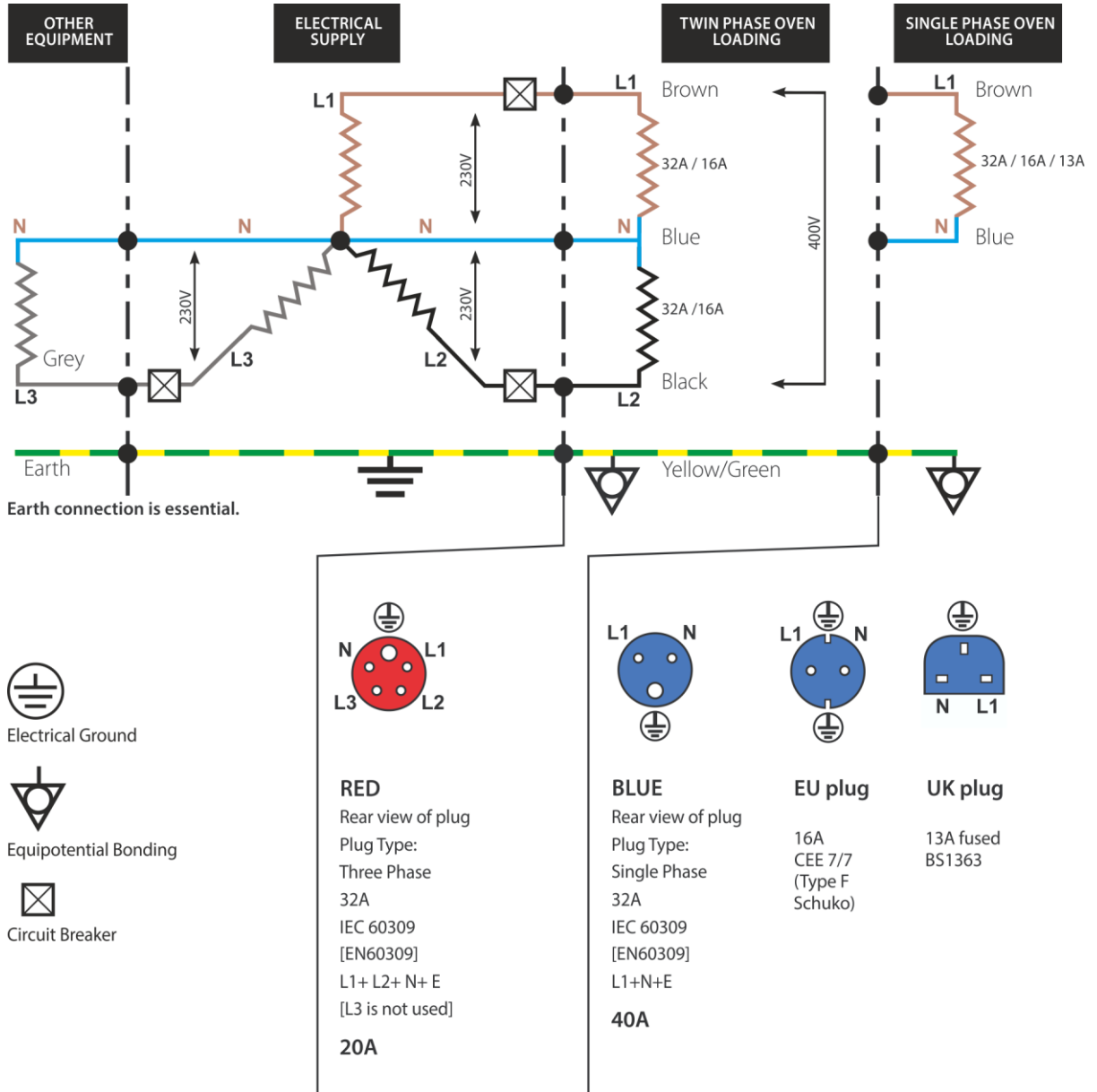

Explanation to phase loading diagram

Phase Loading

Loading per phase is not equal. Therefore it is recommended to connect other electrical equipment to L3+N.

7 Preparing the appliance for use

Purpose of this chapter

This chapter shows you how to put the microwave combination oven into operation and how to cook.

Contents

This chapter contains the following topics:

	Page
Safe working when preparing the appliance for use	55
Procedure for preparing the appliance for use	57
Main menu screen	59
The keyboard screen	60

7.1 Safe working when preparing the appliance for use

For your safety when preparing the appliance for use

Before starting work, make sure that you are familiar with the hazards described under '*Hazards and safety precautions when preparing appliance for use*' on page 28 and in the chapter '*For your safety*' in this Installation and User Manual.

Personal protective equipment for preparing the appliance for use

Wear the personal protective equipment specified in the section '*Personal protective equipment*' on page 37 of the '*For your safety*' chapter for the relevant tasks.

Rules for safe operation of the appliance

To avoid hazards, the following rules must be observed during operation:

- The exhaust vent on the rear of the appliance, and the ventilation holes in the front of the appliance base must not be covered, obstructed or blocked.
- Ensure all appropriate accessories are fitted.

To avoid hazards, the following rules must be observed when operating appliances positioned on a wheeled supporting structure:

- The parking brakes on the front wheels must always be engaged when operating the appliances.
- Check that the wheel brakes are on before operation each day.

Live components

DANGER

Risk of electric shock from live parts

When the appliance is not connected to an equipotential bonding system, there is a risk of electric shock from touching live parts.

- ▷ Make sure that any work on the electrical system is performed solely by a qualified electrician from an authorized service company.
- ▷ Before preparing the appliance for use, make sure that the appliance, including all metallic accessories, is connected to an equipotential bonding system.

Hot surfaces

WARNING

Risk of burns from high temperatures inside the cavity and on the inside of the appliance door

- ▷ You may get burnt if you touch any of the interior parts of the cooking chamber, the inside of the appliance door or any parts that were inside the oven during cooking.
- ▷ Wear personal protective equipment.

Hot steam / vapour

WARNING

Risk of scalding from hot steam and vapour

- ▷ When opening the door, always be cautious of escaping hot steam and vapour which can cause scalding to face, hands, feet and legs.
- ▷ When you are cooling the cavity using the 'cool down' function, step back from the appliance to avoid the hot steam and vapour escaping through the open door.

Excessive microwave energy

⚠ WARNING

Risk of burns from excessive microwave energy

PRECAUTIONS TO AVOID POSSIBLE EXPOSURE TO EXCESSIVE MICROWAVE ENERGY

- ▶ Do not attempt to operate this oven with the door open since open-door operation can result in harmful exposure to microwave energy. It is important not to defeat or tamper with the safety interlocks.
- ▶ Do not place any object between the oven front face and the appliance door or allow soil or cleaner residue to accumulate on sealing surfaces.
- ▶ Do not operate the oven if it is damaged. It is particularly important that the oven door closes properly and that there is no damage to the (1) door (bent), (2) hinges, (3) door seals and sealing surfaces.
- ▶ The oven should not be adjusted or repaired by anyone except properly qualified service personnel.

Radio interference

NOTICE

This is a Class A product. In a domestic environment this product may cause radio interference in which case the user may be required to take adequate measures.

Reduce or eliminate interference to radio, television, or other electrical appliances by doing the following:

- Place electrical appliances as far away from the microwave combination oven as possible.
- Use a properly installed antenna on radio, television, etc. to obtain stronger signal reception.

7.2 Procedure for preparing the appliance for use

Checks prior to preparing the appliance for use

Before preparing the microwave combination oven for use use the checklists below to make sure that all important requirements are met. The appliance must not be put into operation until all the specified requirements are met.

Checklist for moving, setting up and installing the appliance:

- Cardboard packaging and transport securing devices etc. have been removed completely from the appliance.
- The appliance has no signs of damage.
- The appliance has been set up so that it cannot slide about or tip over; the requirements for the installation position and the area around the appliance have been met.
- The appliance is installed in accordance with the installation regulations.

Checklist for safety devices and warnings:





- All safety devices are in their designated position, are working correctly and are secured properly in place.
- All warning signs are in their designated position.

Suitable cooking utensils

Check the manufacturer's instructions and temperature rating to determine the suitability of individual containers or utensils using each of the cooking functions. The following chart provides general guidelines:

Cooking utensils	Permitted	Notice
Heat resistant containers		
Toughened glass	YES	
Compatible vitreous ceramics	YES	Do not use items with metallic decoration.
Earthenware (porcelain, crockery, china, etc.)	YES	
Metallic and foil trays		
Any metal or foil containers	NO	
Plastic containers		
Dual-ovenable plastic containers	YES	Use only plastic containers approved by the manufacturer.
Disposables		
Combustibles (paper, card, etc.)	YES	Use only combustibles approved by the manufacturer.
Other utensils		
Tie tags	NO	
Cutlery	NO	No kitchen utensil should be left in a food product while it is cooking in the cavity.
Temperature probes	NO	

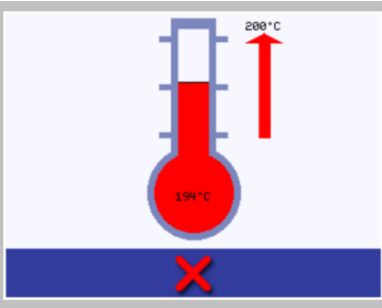
Start up

- | | | |
|----|---|---|
| 1. |  | <p>Make all the relevant safety checks and ensure the appliance is clean and empty.
Then switch the appliance ON.</p> |
| 2. |  | <p>The easyTouch® screen illuminates with the display briefly showing the serial number and appliance data.
If required, to keep the data on the screen, lightly tap the screen once to freeze the display. Tap again to continue.</p> |
| 3. |  | <p>When the appliance is set up with two or more preheating temperatures a choice is displayed.
Scroll arrows at the bottom of the screen indicate that there are more temperature choices not shown on the screen.
If necessary, use the scroll arrows. Then select the temperature required to start preheating the cavity.</p> |
| 4. |  | <p>During preheating the display shows the progress as the cavity heats up to the set temperature.
To stop the cavity heating up touch the red 'X' symbol at the bottom of the screen.</p> |
| 5. |  | <p>The appliance is ready to use when the 'cookbook' is displayed.</p> |

Customer guidance and instruction





Instruct the user regarding all safety-related functions and devices.
Instruct the user in how to operate the appliance.

7.3 Main menu screen

Appearance



The buttons and what they do

Button	Meaning	Function
	Development Mode	'Development Mode' enables multistage cooking profiles to be developed, then stored under a name and symbol for reuse.
	Press&Go	'Press&Go' allows quick access to use the cooking profiles that are already stored.
	Cookbook	'Cookbook' contains the cooking profiles stored in the memory of the appliance. It displays favourites, cooking profile groups and a complete listing of all cooking profiles available.
	Cleaning / Temp change	'Cleaning / Temp change' allows the cavity temperature to be changed and the appliance to be prepared for cleaning with reminders displayed to assist during the cleaning process.
	Settings	'Settings' are used to control the appliance settings and functions including time and language, loading cooking profiles and for service and maintenance purposes.

The easyTouch screen display









The easyTouch® screen display, layout and icons shown herein are for guidance purposes only and are not intended to be an exact representation of those supplied with the appliance.

7.4 The keyboard screen

Appearance



The buttons and their functions

Button	Meaning	Function
	Keyboard screen	The keyboard screen is used to enter an authorised password to enter data for programmes and may restrict operator access to some functions.
	Clear screen	Select the 'clear screen' key to delete text from the keyboard screen.
	Keyboard	Type in text using the keyboard.
	Spacebar	Select the 'spacebar' key to insert a blank.
	Return	Select the 'return' key to start a new line.
	Keyboard scroll	Select the up/down arrows to scroll the keyboard screen.
	Enter / OK	Select the green check mark to confirm settings and continue.
	Previous screen	Select the 'backspace' key to return to a previous screen.

Character length

- For names of cooking profiles, names of cooking profile groups and passwords use 1-20 characters in 2 lines max.
- For stage instructions of individual cooking profiles use 1-54 characters in 5 lines max.

8 Cooking procedures

Purpose of this chapter

This chapter shows you how to operate the microwave combination oven for cooking and what procedures to follow for cooking.

The 'Operating principles and instructions for cooking' is a step-by-step guide to the cooking procedures.

Contents

This chapter contains the following topics:

	Page
Operating principles and instructions for cooking	62
Operation instructions: Full Serve Mode	68

8.1 Operating principles and instructions for cooking

Contents

This section contains the following topics:

	Page
Working safely with the appliance	63
Turning the oven on and off	65
How to cook	66



8.1.1 Working safely with the appliance

Your safety and the safety of your staff

Before your personnel start working with the microwave combination oven for the first time, familiarize yourself with the information contained in the chapter '*For your safety*' on page 14 and make relevant safety arrangements.

Instruct your personnel to learn the safe-working rules given in this section before starting work, and to follow them strictly.

Instruct your personnel to familiarize themselves with the hazard warnings listed in this section and in further instructions below, and instil in them the importance of taking the specified precautions.

Personal protective equipment for your personnel

Instruct your personnel to wear the correct personal protective equipment specified in the section '*Personal protective equipment*' on page 37 of the '*For your safety*' on page 14 chapter for the relevant tasks.

Rules for safe operation

To avoid hazards, the following rules must be observed during operation:

- The air outlets on the rear of the appliance, and the air inlets on the front of the appliance underneath the door must not be covered, obstructed or blocked.

Additional rules for safe operation on a wheeled trolley

To avoid hazards, the following rules must be observed when operating appliances positioned on a wheeled trolley:

- The parking brakes on the front wheels must always be engaged when operating the appliances.
- Check that the wheel brakes are on before operation each day.

Handling heavy loads

Inform your personnel that lifting heavy containers and moving heavy transport trolleys may result in tiredness and discomfort, and faults may occur with the moving equipment.

Hot surfaces

▲WARNING

Risk of burns from high temperatures inside the cavity and on the inside of the appliance door

You may get burnt if you touch any of the interior parts of the cavity, the inside of the appliance door or any parts that are or were inside the oven during cooking. Wear personal protective equipment.

Hot steam / vapour

▲WARNING

Risk of scalding from hot steam and vapour

Escaping hot steam and vapour can cause scalding to face and hands.

- ▷ When opening the door and when cooling the cavity using the 'Cool Down' function, step back from the appliance to avoid the hot steam and vapour hit your body after escaping through the open door.

Hot liquids

⚠WARNING

Risk of scalding from hot liquids

Spilling liquid foods can result in scalds to face and hands.

- ▷ Only use containers of appropriate size.
- ▷ Insert the food containers correctly.
- ▷ Always place containers holding liquids or holding food that will liquefy during cooking on shelves that allow a proper view into the container for all users. Always take out horizontally any containers holding liquids or holding food that will liquefy during cooking.
- ▷ Wear personal protective equipment.

Excessive microwave energy

⚠WARNING

Risk of burns from excessive microwave energy

PRECAUTIONS TO AVOID POSSIBLE EXPOSURE TO EXCESSIVE MICROWAVE ENERGY

- ▷ Do not attempt to operate this oven with the door open since open-door operation can result in harmful exposure to microwave energy. It is important not to defeat or tamper with the safety interlocks.
- ▷ Do not place any object between the oven front face and the appliance door or allow soil or cleaner residue to accumulate on sealing surfaces.
- ▷ Do not operate the oven if it is damaged. It is particularly important that the oven door closes properly and that there is no damage to the (1) door (bent), (2) hinges, (3) door seals and sealing surfaces.
- ▷ The oven should not be adjusted or repaired by anyone except properly qualified service personnel.

Break in the cold chain

⚠WARNING

Risk of microbiological contamination of foods



- ▷ Never use the appliance for temporary storage of food.
- ▷ Never intentionally interrupt the cooking process.
- ▷ Once the appliance is running again after a power failure, consider how the length of time taken to resume operation will affect the food condition. If in doubt discard the food.

8.1.2 Turning the oven on and off

⚠ For your safety when using the microwave combination oven



Before starting work, it is essential that you familiarize yourself with the rules and hazard warnings specified in '*Working safely with the appliance*' on page 63, and follow the instructions given there.

Switching on the microwave combination oven

- | | | |
|----|---|--|
| 1. |  | Switch on the microwave combination oven. |
| 2. |  | Wait until the software is ready for use.

NOTE:
The main menu screen visible on the left is only displayed in Full Service Mode. |

Switching off the oven at the end of the working day

- | | | |
|----|---|---|
| 1. | | Perform the necessary cleaning tasks as specified in the cleaning schedule. |
| 2. |  | Switch off the microwave combination oven. |
| 3. |  | Leave the appliance door ajar in order to let moisture escape.

NOTE:
Switch off the power on site before prolonged breaks in use. |

8.1.3 How to cook

▲ For your safety when using the microwave combination oven

Before starting work, it is essential that you familiarize yourself with the rules and hazard warnings specified in '*Working safely with the appliance*' on page 63, and follow the instructions given there.

Requirements

- You are sufficiently familiar with using the software to be able to select saved cooking profiles or enter new cooking profiles that are suitable for the food you wish to cook, and to run these profiles.
- The microwave combination oven and accessories and fittings used have been cleaned properly.
- There are no foreign objects in the cavity.
- The air filter is fitted in place on the oven front underneath the appliance door.

How to cook

1. Select a cooking profile from the cookbook or enter a new cooking profile.
2. Follow the prompts displayed by the software.
3. Open the appliance door.
4. Place the prepared food in the microwave combination oven.
5. Close the appliance door again.
6. Start the cooking process.
7. Wait for the cooking process to finish.
8. An audible signal is given when the cooking process is finished. Follow the prompts displayed by the software.
9. Open the appliance door.
10. Take out the food.
11. Close the appliance door again.

Using a cooking profile (Quick Serve Mode)

1.  Select the 'all menus' symbol.

<p>2.</p>		<p>Use scroll up/down arrows to find the cooking profile.</p> <p>NOTE: If a picture has a red frame around it the cavity temperature is set too high or too low for that cooking profile. See '<i>Changing the cooking chamber temperature</i>' on page 74. Ensure that a food product is placed into the cavity before starting a cooking profile. Take all the necessary precautions to ensure that you do not burn yourself. Open the appliance door, place the food product into the hot cavity and close the door.</p>
<p>3.</p>		<p>Select the required cooking profile to start cooking. <i>Example: 'ITALIAN SUB x 1'.</i></p> <p>WARNING: Hot surfaces at the door and in the cavity</p>
<p>4.</p>		<p>The cooking profile either starts immediately displaying a countdown timer, or an instruction is displayed first. Follow the stage instruction and then press the green check mark to start the cooking profile.</p>
<p>5.</p>		<p>The cooking timer counts down to zero and makes a sound to indicate that an operator action is required at the end of a cooking profile or of a stage of a cooking profile. Open the door after the cooking profile has finished and remove the food product from the cavity. The display then returns to the 'cookbook' screen automatically.</p> <p>NOTE:</p> <ul style="list-style-type: none"> Opening the door during cooking stops the cooking profile and a warning appears. Closing the door allows the user to continue or cancel the cooking profile. <p>To check the cavity temperature when cooking, lightly tap the temperature displayed. The cavity temperature is shown with an asterisk.</p>

8.2 Operation instructions: Full Serve Mode



Contents

This section contains the following topics:



	Page
The Press&Go Menu	69
Using a cooking profile	70
Creating a cooking profile	71
Using a cooking profile	74
Managing cooking profile groups	77
Basic settings of your microwave combination oven	81
Using a USB stick	89

8.2.1 The Press&Go Menu

Running a cooking profile from the Press&Go menu

- | | | |
|----|---|---|
| 1. |  | Select 'Press&Go' from the main menu screen. |
| 2. |  | Select the cooking profile required to cook. |
| 3. |  | The display shows the cooking time count down. The timer bar turns red to indicate that the cooking cycle has finished. |

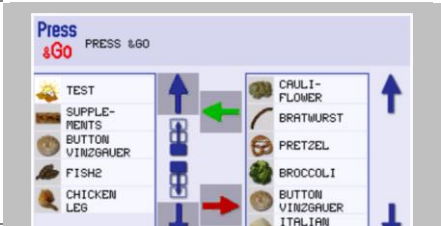
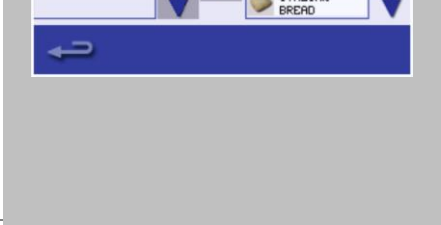
Choosing which cooking profiles are shown in the Press&Go menu screen

- | | | |
|----|---|---|
| 1. |  | After selecting 'Press&Go' from the main menu screen, select the 'edit cookbook' symbol. |
| 2. |  | Two lists are displayed. The list on the left shows the cooking profiles being part of the 'Press&Go' menu. The list on the right shows other cooking profiles which are available. Both lists can be scrolled up or down using the blue arrows on the right of each list. |
| 3. |  | Select a cooking profile from the list on the left. Choose whether to change its position within the list or to remove it into the list on the right. To change the order of cooking profiles in the left list use the blue up/down arrows in the middle. To move a selected cooking profile to or from the 'Press&Go' menu use the green/red arrows in the middle. |
| 4. | | To make a cooking profile from the right list available in the 'Press&Go' menu move it into the left list. |
| 5. |  | Select backspace to return to the 'Press&Go' menu screen when finished. |

8.2.2 Using a cooking profile

Using a cooking profile

1. 

Select the 'cookbook' symbol from the main menu screen.

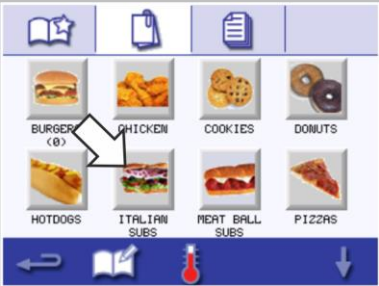
2. 

Select a group of cooking profiles, for example 'ITALIAN SUBS', to display the individual cooking profiles.

3. 

Select a cooking profile to start, for example 'ITALIAN SUB x 2'.

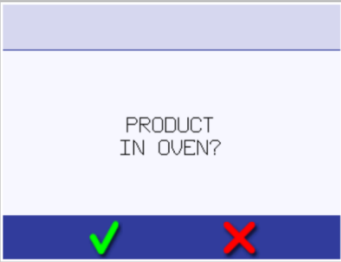
4. 

Follow any instructions on the screen, if displayed. Press the green check mark to cook.

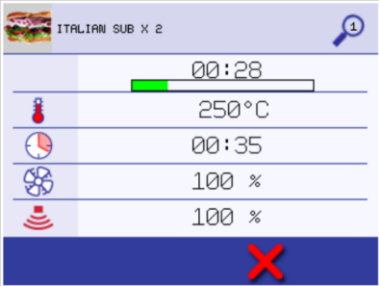
5. 

The cooking time counts down for each program stage.

6. 

When the cooking profile ends a red bar is displayed usually with an audible sound. Open the door or touch the red 'X' to return to the cooking profile. Opening the appliance door during cooking stops the cooking profile and displays a warning. Closing the door allows the user to continue or cancel the cooking profile.

8.2.3 Creating a cooking profile

Creating a cooking profile

1. 

Select the 'chef's hat' symbol from the main menu screen to enter the Development Mode.

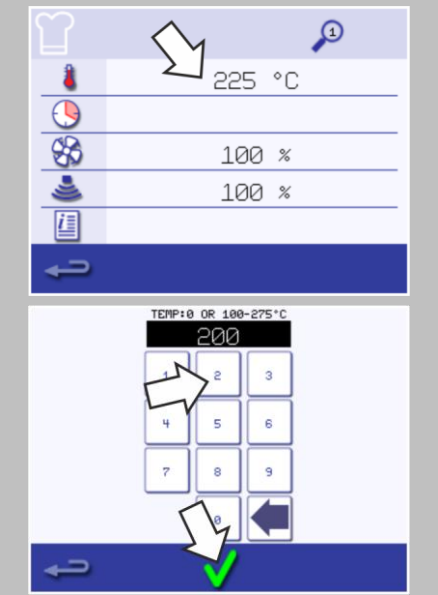
2. 

The temperature value displays the set temperature for pre-heating the cavity.
To increase or decrease the temperature required, select the 'temperature' symbol, enter a temperature value in the keypad within the limits displayed.
Select the green check mark to continue.

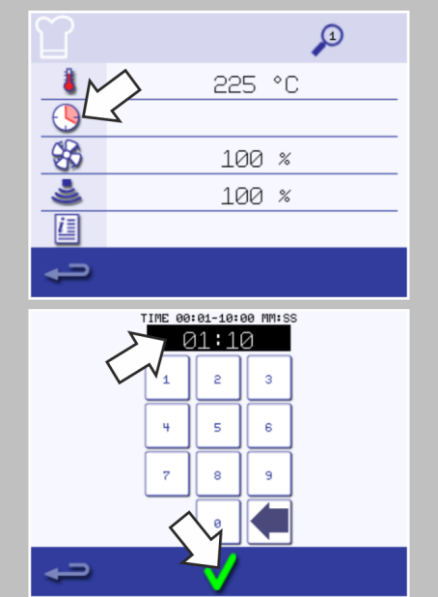
3. 

Select the 'clock' symbol.
Enter the cooking time in the keypad up to a maximum of 10 minutes for each stage.
Example: Enter 110 (for 1 minute and 10 seconds).
Select the green check mark to save the inserted value.

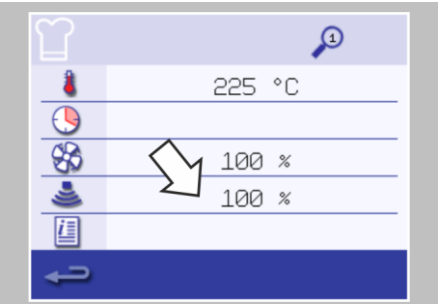
4. 

Select the 'microwave' symbol.
Set the microwave power in the keypad (0 and 5-100%).
Select the green check mark to save the inserted value.

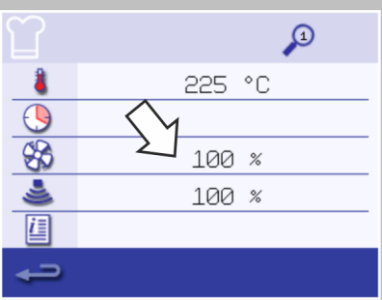
5. 

Select the 'fan' symbol to set the fan speed within the limits shown on the screen.
Select the green check mark to save the inserted value.

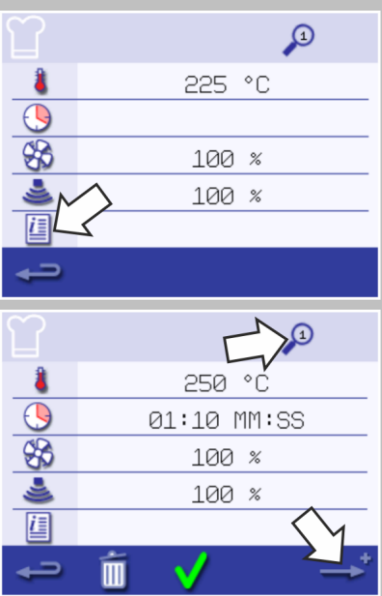
6. 

Select the 'information' symbol to enter an instruction of a stage (optional).
Example: "Stage 1 - place a food product into the cavity".
When cooking the instruction appears in the display at the beginning of that stage.
Select the green check mark to save the inserted instruction.
Select the right arrow with a 'plus' symbol at the bottom to add a new stage.
Delete a stage by pressing the 'dustbin' symbol.

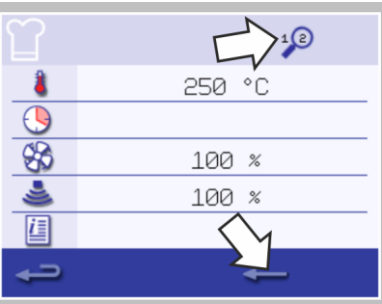
7. 

Cooking profiles can have up to a maximum of 6 stages.
Repeat the steps 2-6 from stage 1 above to create a new stage.
The 'magnifier' symbol at the top indicates which stage is displayed on the screen.
Select the left/right arrow displayed at the bottom to shift between the set stages.

Running and saving a cooking profile

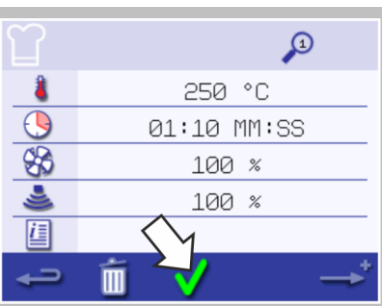
1. 

Press the green check mark to confirm the cooking profile.

WARNING:
Ensure that a food product is in the cavity and that all safety precautions are followed before running the cooking profile.

2. 

Select the 'start' symbol to run the cooking profile (optional).
If the results are not satisfactory, select the backspace symbol, change the cooking settings and retest.
3. 

Select the 'save cookbook' symbol to record the cooking profile to the cookbook.
4. 

Select the 'camera' symbol to open pictures.
5. 

Select a picture to represent the new cooking profile.
Use the scroll arrows for displaying more pictures.
6. 

Enter a name for the cooking profile, using a maximum of 20 characters, for example, '1 PIZZA'.
Press the green check mark to save the cooking profile to the cookbook.
A green check mark on a 'cookbook' symbol indicates that the cooking profile has been saved to the cookbook.

8.2.4 Using a cooking profile

Changing the cavity temperature

1. 

Take note of the cavity temperature required for the cooking profile.
Then press the green tick to continue.

2. 

Select the 'temperature' symbol.

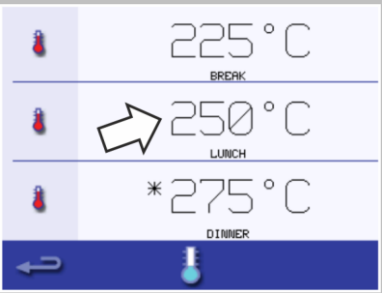
3. 

An asterisk next to the temperature value indicates the present cavity temperature.
Select the required cavity temperature for the cooking profile, for example 250°C / 482°F.
Once the cavity reaches the required temperature continue from selecting the 'cookbook' in step 1.



Viewing and editing cooking profiles

1. 

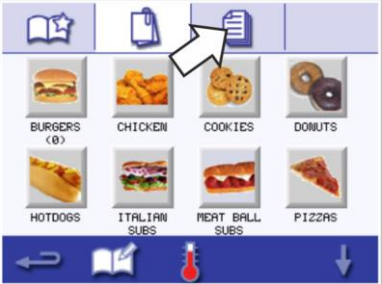
Select the 'cookbook' symbol from the main menu screen.

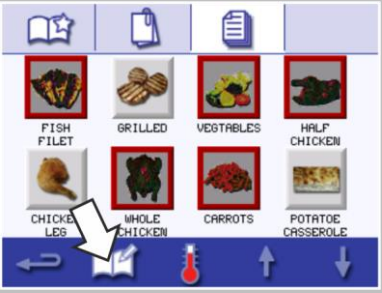
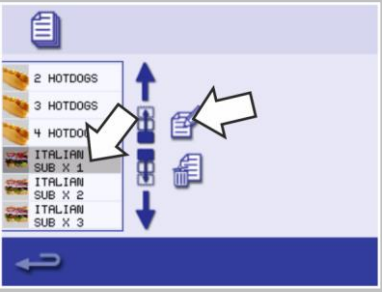

2. 

Select the 'all menus' symbol.

3.  Select the 'edit cookbook' symbol.
4.  Use the up/down scroll arrows on the right side of the screen to find the cooking profile, for example 'ITALIAN SUB x 1'.
Select the 'view/edit cooking profile' symbol.
5.  View or adjust the cooking profile as required.
See 'Development Mode' for details.

Move a cooking profile in a group of cooking profiles

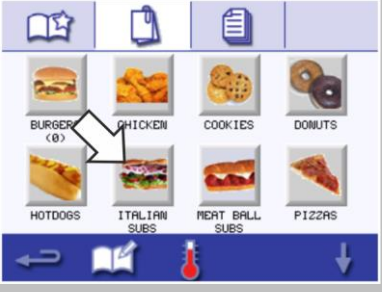
Example: Moving the position of the 'ITALIAN SUBS x 4' cooking profile within the group of cooking profiles called 'ITALIAN SUBS'.

1.  Select the 'cookbook' symbol from the main menu screen.
2.  Select the 'ITALIAN SUBS' group of cooking profiles.
3.  Select the 'edit cookbook' symbol.

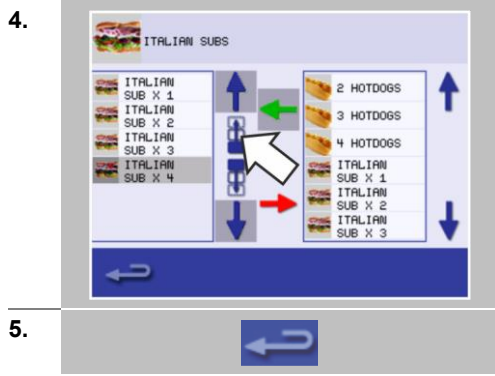

4. Select the cooking profile to be moved, for example 'ITALIAN SUB x 4'.
Use the up/down arrows on the left side of the 'edit' screen to move the selected cooking profile within the group of cooking profiles.

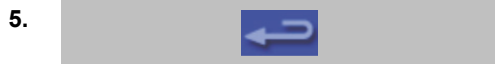

5. Press the backspace button to return to the 'cookbook' screen.

Add a cooking profile to a group of cooking profiles

Example: Add a cooking profile 'ITALIAN SUB x 4' to the group of cooking profiles 'ITALIAN SUBS'.



1. Select 'cookbook' from the main menu screen.

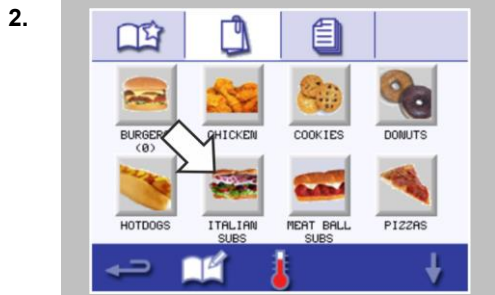

2. Select the group of cooking profiles 'ITALIAN SUBS'.



3. Select the 'edit cookbook' symbol.

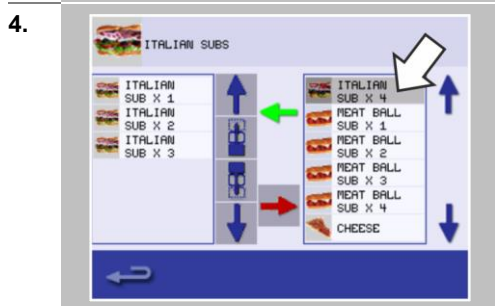

4. Use the up/down scroll arrows on the right side on the right part of the screen to find and select the 'ITALIAN SUB x 4' cooking profile.

- | | | |
|-----------|--|---|
| <p>5.</p> | | <p>Select the green 'left' arrow to add the 'ITALIAN SUB x 4' cooking profile to the group of cooking profiles in the left part of the screen.
Then select backspace to return to the cooking profiles.</p> |
| <p>6.</p> | | <p>Select backspace to go back to the 'cookbook'.</p> |

8.2.5 Managing cooking profile groups

Move a cooking profile group in a list of cooking profile groups

- | | | |
|-----------|--|---|
| <p>1.</p> | | <p>Select the 'cookbook' symbol from the main menu screen.</p> |
| <p>2.</p> | | <p>Select the 'edit cookbook' symbol.</p> |
| <p>3.</p> | | <p>Use the big scroll arrows to locate all cooking profile groups.</p> |
| <p>4.</p> | | <p>Select the group of cooking profiles to be moved.
Use the small up and down arrows in the centre of the screen to move the selected cooking profile within the list.</p> |
| <p>5.</p> | | <p>Select the backspace button to return to the 'cookbook'.</p> |

Adding a new cooking profile group

1.  Select 'cookbook' from the main menu screen.

2.  Select the 'edit cookbook' symbol.

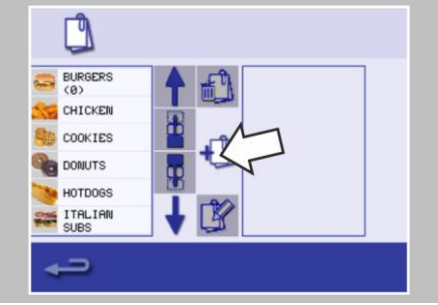
3.  Select the 'add a new cooking profile group' symbol.

4.  Select the 'camera' symbol to open a pictures database.

5.  Select a picture from the database to represent the cooking profile group.
Use the scroll arrows at the bottom of the screen for more pictures.

6.  Enter a name for the new cooking profile group (max. 20 characters).
Press the green check mark to save the cooking profile group to the cookbook.

7.  Select the backspace button to go back to the 'cookbook'.

Edit a selected cooking profile group name

1.  Select the 'cookbook' symbol from the main menu screen.

2.  Select a cooking profile group.

3.  Select the 'edit cookbook' symbol.

4.  Select the 'edit cooking profile group' symbol.

5.  Enter the new name of the cooking profile group.
Select the green check mark to continue.

Deleting a cooking profile group

1. 

Select the 'cookbook' symbol from the main menu screen.

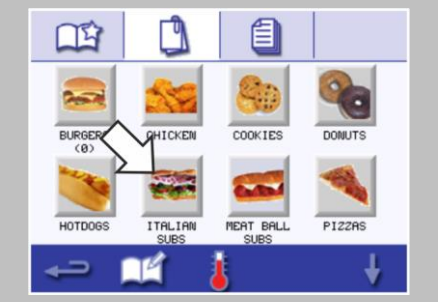
2. 

Select a cooking profile group.

3. 

Select the 'edit cookbook' symbol.

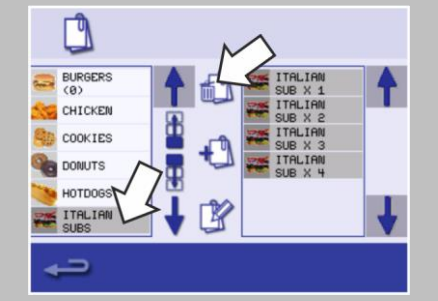
4. 

Select the cooking profile group you want to remove from the cookbook.
Select the 'delete cooking profile group' symbol.

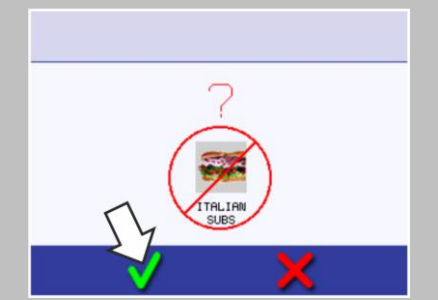
5. 

Select the green check mark to delete the cooking profile group.

NOTE:
Deleting a cooking profile group from the cookbook does not mean deleting it from the 'all menus list'.

8.2.6 Basic settings of your microwave combination oven

Control settings and icons

1. 

Select the 'settings' symbol from the main menu screen.

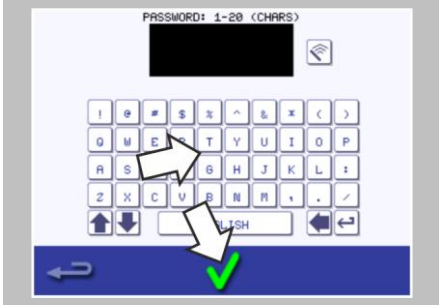
2. 

Enter the password.
Select the green check mark to display the 'settings' menu.

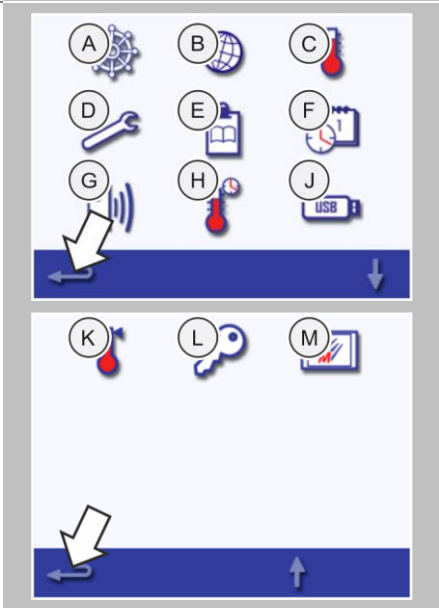
3. 

The 'settings' menu comprises the following functions:

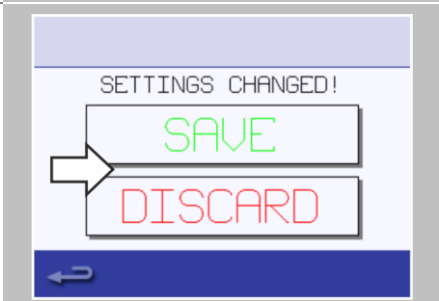

 - A. Operating mode / navigation settings
 - B. Language options
 - C. Temperature settings and labels
 - D. Service information and error logs (password required)
 - E. Cooking profile counters
 - F. Date and time settings
 - G. Speaker sound levels
 - H. Timer (Temperature / ON / OFF)
 - J. USB program connection
 - K. Temperature band ("Temp Band")
 - L. Change settings / service access passwords
 - M. Screen saver

When finished with a setting, select backspace to return to the main settings menu.
Use the up/down scroll arrows at the bottom of the screen to display all functions of the 'settings' menu.

4. 

Press the backspace button to exit the 'settings' menu.
A prompt appears to either 'SAVE' or 'DISCARD' any changed settings.

Operating mode/navigation settings

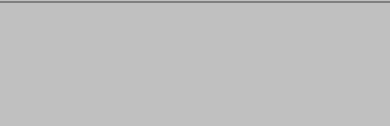
- | | | |
|----|--|---|
| 1. |  | <p>Select the 'operating mode / navigation' symbol from the 'settings' menu.</p> |
| 2. |  | <p>Select 'QUICK SERVE MODE' for cooking only.
 Select 'FULL SERVE MODE' for creating cooking profiles.
 Select 'MANUAL MODE' to manually cook only via the 'chef's hat' symbol on the main menu screen.
 Select 'ENABLE SETTINGS' to display an 'unlock' symbol on the 'Quick Serve Mode' screen to allow access to the 'settings' menu.</p> |
| 3. |  | <p>Select 'MAGNETRON ENERGY DELAY' to enable a magnetron warm up period for all cooking profiles.
 Select 'ENERGY SAVING' to enable the hibernation mode when the oven is inactive.</p> |

NOTE:

If a green check mark is displayed the corresponding function is active.

Language options

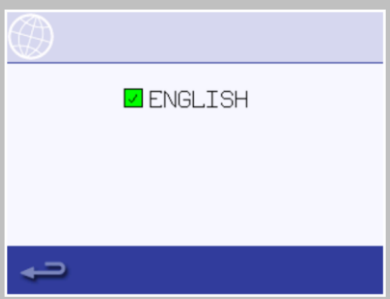
- | | | |
|----|---|---|
| 1. |  | <p>Select the 'globe' symbol.</p> |
| 2. |  | <p>Select the checkbox(es) of the required language(s) from the list shown.</p> |

Cavity temperature settings and labels



Select the 'temperature' symbol to change the cavity preheat temperature.
 Enter the required temperature on the appearing keypad and select OK.
 The temperature options screen is only displayed at start up when two or more cavity temperatures are set above minimum.

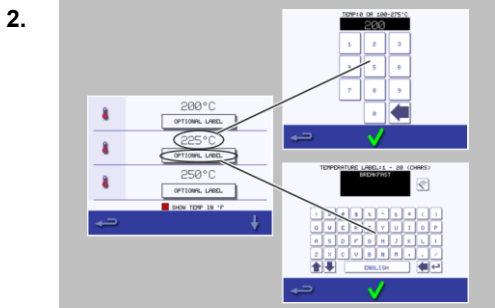

To change a temperature label, select the label.
 Enter the required label name on the appearing keypad and select OK.

Service information and error logs

For service information and error logs refer to '*Rectifying faults*' on page 113.

Cooking profile counters

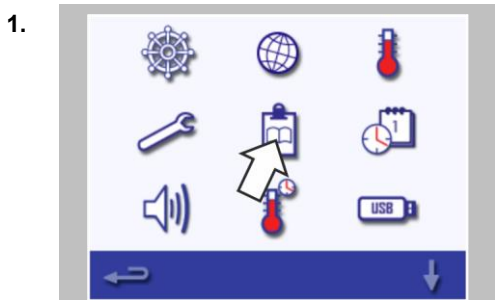

Select the 'clipboard' symbol to display a listing of cooking profile counters.

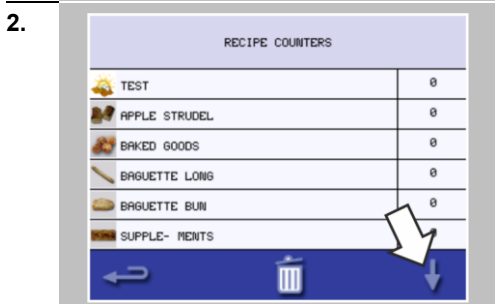

If the list of cooking profile counters is shown, use the up/down arrows at the bottom of the screen to scroll it.

Date and time settings

1.



Select the 'clock/date' symbol to display the setting options.

2.

Change the date:

2.1

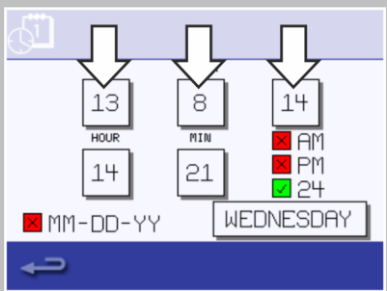

Select 'MONTH', enter the correct month on the keypad and select OK.

2.2

Select 'DAY', enter the correct day on the keypad and select OK.

2.3

Select 'YEAR', enter the correct last two digits of the year on the keypad and select OK.

To display the month first, followed by the day and year, select the 'MM-DD-YY' checkbox.

A correct date supports servicing as the error logs are recorded using these date settings.

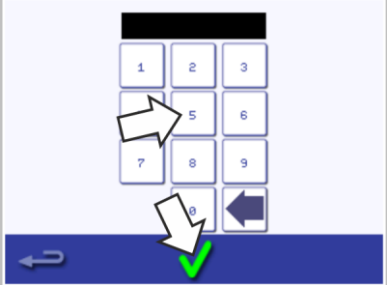

3.

Change the time:

3.1

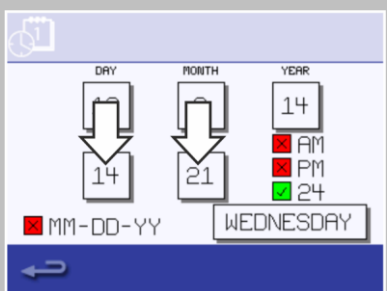

Select 'HOUR', enter the correct hour on the keypad and select OK.

3.2

Select 'MIN', enter the correct minutes on the keypad and select OK.

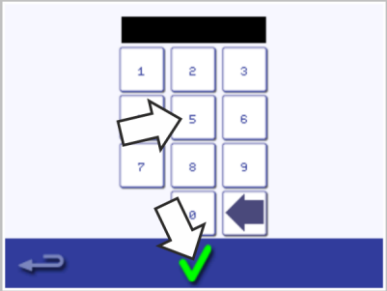

3.3

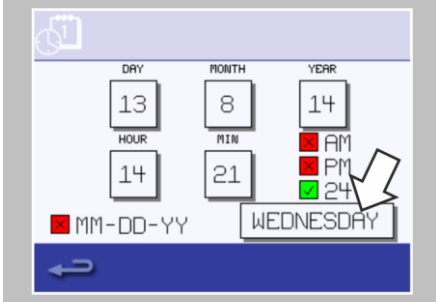

Select the day name shown to cycle through to display the correct weekday.

Sound levels

1.



Select the 'speaker' symbol to access the volume, tone and further sound settings.

2.



Select the 'speaker' symbol to adjust the volume level suitable for the environment from none (OFF) to the loudest (100%).

3.

Select the 'music note' symbol to set LOW, MED or HIGH tone.

4.

Select the 'keypad' symbol to switch the sound ON or OFF when the touchscreen is pressed.

Oven timer

1. 

Select the 'thermometer / timer' symbol.

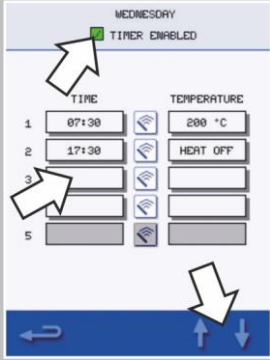
2. 

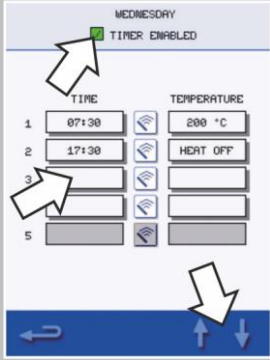
Select the 'timer enabled' checkbox (green tick).
3. 

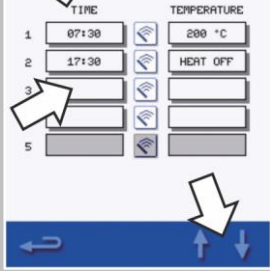
Select a weekday using the up/down arrows at the bottom of the screen.
4. 

	TIME	TEMPERATURE
1	07:30	200 °C
2	17:30	HEAT OFF
3		
4		
5		

Select an empty 'time' box (maximum of 5 per day).
Alternatively clear the 'time' box using the 'wipe' symbol next to it.

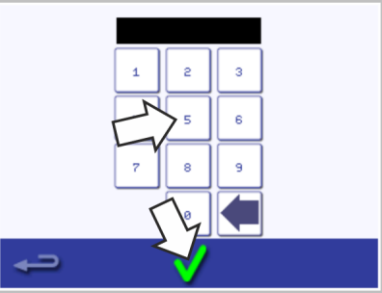
5. 

Enter the start time on the keypad.
Press the green tick to continue.

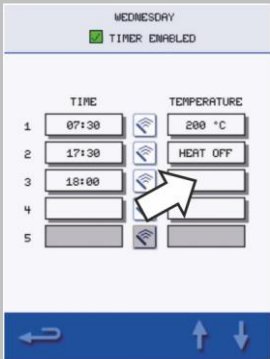
6. 

	TIME	TEMPERATURE
1	07:30	200 °C
2	17:30	HEAT OFF
3	18:00	
4		
5		

Select an empty 'temperature' box opposite the 'time' box displaying the time just entered.
Alternatively clear the 'temperature' box using the 'wipe' symbol next to it.

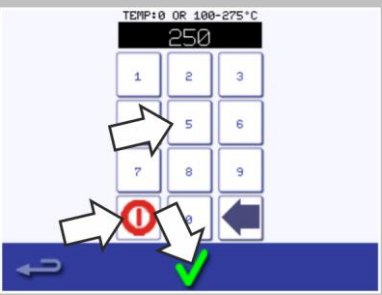
7. 

Enter the cavity temperature required on the keypad.
Alternatively select zero to turn the heat OFF.
Alternatively select the red circle symbol to switch OFF the appliance.
Press the green tick to continue.

Temperature Band

1.

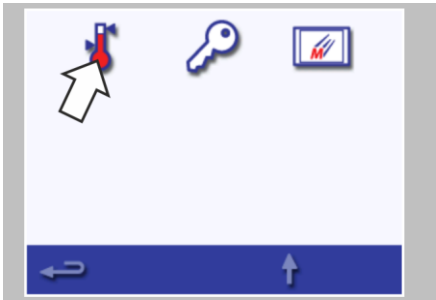

Select the 'Temp Band' symbol.

2.

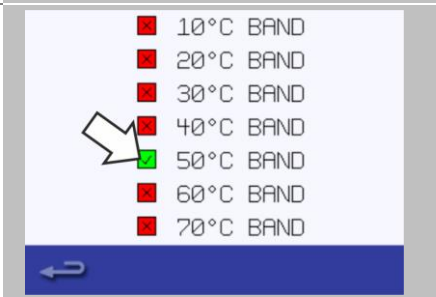

Select the required temperature band checkbox, shown by a green tick.

Generally the lowest practical 'Temp Band' should be chosen.

If the set cavity temperature falls by more than the selected 'Temp Band' value, the ready to cook mode and the 'Temp Band' are deactivated until the cavity reaches the preset preheat temperature.

Change password

1.



Select the 'key' symbol to change the passwords of the appliance.

2.

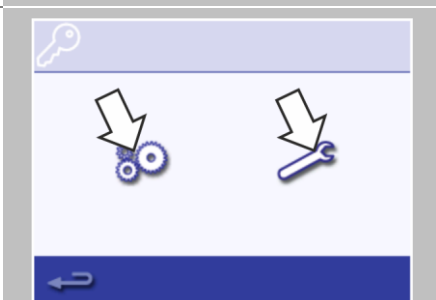

Select the appliance 'settings' or 'service' symbol.

3.

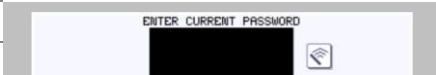

Enter the existing password and press the green tick to confirm.

4.

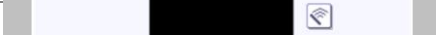

Enter a new password and press the green tick.

5.

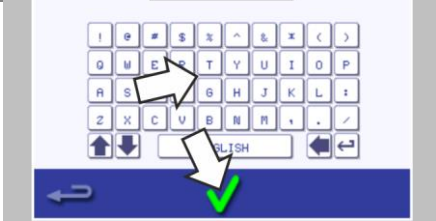

Confirm the new password and press the green tick again.

Set screen saver

1.



Select the 'ENABLED' checkbox to switch the screen saver ON or OFF.
Select the 'time' box below.

2.

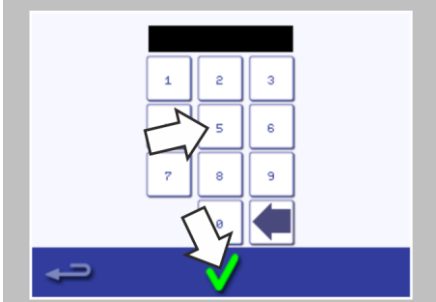

Enter a time delay on the keypad from 1 to 60 minutes before the screen saver starts.
Press the green check mark to confirm.

3.



An active screen saver will mask the screen showing a moving image.
To use the touchscreen, tap the screen to deactivate the screen saver.

8.2.7 Using a USB stick

⚠ For your safety when using the appliance

Before starting work, it is essential that you familiarize yourself with the rules and hazard warnings specified in '*Working safely with the appliance*', and follow the instructions given there.

Purpose of the USB cover

The USB cover protects the USB port so that no water vapour can get into the control electronics during cooking or cleaning.

During cooking and cleaning, there must not be a USB stick inserted and the USB port must be closed by the cover.

USB programs

IMPORTANT:

Downloading from a USB memory stick will clear all the existing programs in the memory of the appliance.

Check that the key has the correct number/code for the programs you want to load into the memory (1 'cbr' + 'autoupd.ate').

1.

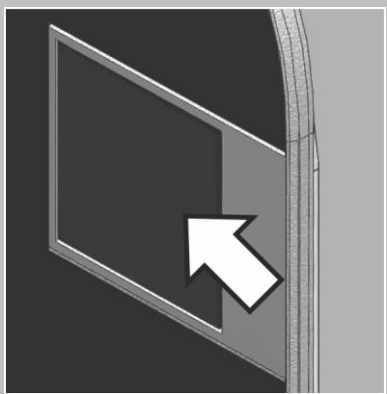

Switch the appliance OFF.

Open the cover to the USB port on the control panel.

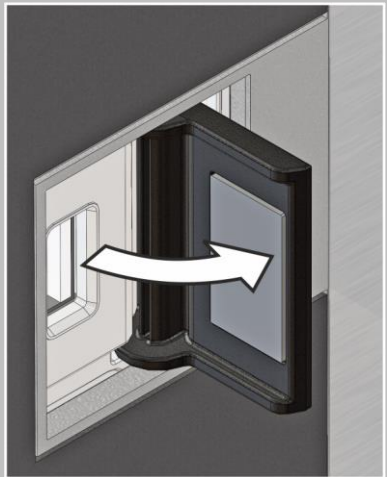

2.

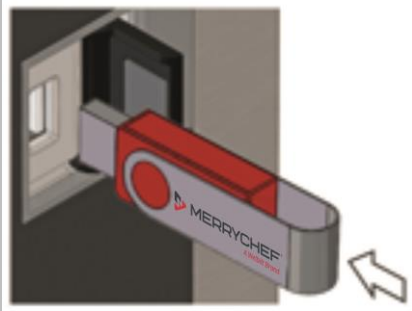

Plug in the USB memory stick.
If the USB memory stick is too large, use a standard commercial adapter cable.

3.



Switch the appliance ON.
The files automatically download from the USB memory stick showing the progress and confirmation screens for the update.

4.



On completion the appliance displays the start up screen.
Then the thermometer symbol is displayed.
Remove the USB memory stick and keep it in a safe place.

9 Cleaning procedures

Purpose of this chapter

This chapter summarizes the cleaning methods, the cleaning chemicals and how to handle them and the cleaning instructions. It explains the correct procedure to follow when cleaning the microwave combination oven.

Contents

This chapter contains the following topics:

	Page
Daily cleaning tasks	92
Cleaning chemicals	92
Items required for cleaning	93
Safe working when cleaning	94
Cleaning procedures	96

9.1 Daily cleaning tasks

What must be cleaned?	Procedure	Cleaning chemicals
Cavity	Clean by hand with a soft cloth / paper towel	Cleaning and protective chemicals approved by the manufacturer
Outside of appliance	Clean by hand with a soft cloth	Common household stainless steel cleaner or hard surface cleaner
Containers, baking sheets, shelf grills and other accessories used for cooking	<ul style="list-style-type: none"> ▪ Clean by hand with a soft non-abrasive sponge ▪ Rinse off after with water 	Common household detergent

9.2 Cleaning chemicals

Cleaning chemicals

Use solely the cleaning chemicals specified here to clean the microwave combination oven and its accessories.

Product	Use
Merrychef Cleaner	Cleaning the cavity and appliance door
Merrychef Protector	Protecting the cavity and appliance door
Common household stainless steel cleaner or hard surface cleaner	Caring for the external surfaces of the microwave combination oven
Common household detergent: mild on skin, alkali-free, pH-neutral and odourless	<ul style="list-style-type: none"> ▪ Cleaning components and fittings according to relevant instructions ▪ Cleaning containers, baking sheets, shelf grills and other accessories used for cooking

Handling the cleaning chemicals

You must wear personal protective equipment when using certain cleaning chemicals.

Follow the instructions given in the chapter '*Personal protective equipment*' on page 37 and the current safety datasheets pertaining to cleaning and protective chemicals recommended by the manufacturer.

Personnel must be trained regularly by the person responsible for the microwave combination oven.

9.3 Items required for cleaning

Items required for cleaning

- Merrychef cleaning chemical
- Merrychef protective chemical



- Protective rubber gloves
- Non-abrasive nylon scrub pad
- Cleaning towel and cloths
- Eye protection
- Heat proof gloves (optional)
- Dust mask (optional)



NOTICE

- Never use sharp implements or harsh abrasives on any part of the appliance.
- Do not use tools.
- Do not use caustic cleaners on any part of the appliance or cavity. It will cause permanent damage to the catalytic converters.



9.4 Safe working when cleaning

Your safety and the safety of your staff

Before your personnel start working with the microwave combination oven for the first time, familiarize yourself with the information contained in the chapter '*For your safety*' on page 14 and make relevant safety arrangements.

Instruct your personnel to learn the safe-working rules given in this section before starting work, and to follow them strictly.

Instruct your personnel to familiarize themselves with the hazard warnings listed in this section and in further instructions below, and instil in them the importance of taking the specified precautions.

Personal protective equipment for your personnel

Instruct your personnel to wear the correct personal protective equipment specified in the section '*Personal protective equipment*' on page 37 of the '*For your safety*' on page 14 chapter for the relevant tasks.

Rules for moving and setting up the wheeled trolley safely

To avoid hazards, the following rules must be observed when moving the wheeled trolley that carries the appliances (optional accessory):

- Watch out for all connecting cables when moving appliances. Never wheel over the connecting cables. Never stretch let alone pull off the connecting cables.
- The appliances must be disconnected from the electrical supply before moving the stacking kit (optional accessory).
- The appliances must be left to cool down on the trolley before being moved.
- There must not be any food left in the appliances.
- The appliance door must be closed.
- Protective clothing must be worn if the appliance is mounted on a trolley.
- It is important to ensure that the unit is level once is back in place.
- Once the unit is back in place, the parking brakes must be engaged again.
- Whatever the position, care must be taken to ensure that the trolley carrying the appliance does not tip over.

Spraying down the appliance with water

⚠ DANGER

Risk of electric shock from live parts

Water on the exterior of the appliance can cause a short-circuit, which may result in electric shock on touching the appliance.

- ▷ Do not spray the interior and exterior of the appliance with water.
- ▷ Always keep the USB cover closed during cleaning.

Hot surfaces

⚠ WARNING

Risk of burns from high temperatures on interior parts of the appliance

You may get burnt if you touch any of the interior parts of the cavity, the inside of the appliance door or any parts that are or were inside the oven during cooking.

- ▷ Before starting cleaning tasks, wait until the cavity has cooled to below 50°C / 122°F or use the Cool Down function to cool the cavity.
- ▷ Wear personal protective equipment.

Spraying water into a hot cavity

▲WARNING

Risk of scalding from hot steam

If water is sprayed into the hot cavity, steam will be produced that may scald.

- ▷ Before starting cleaning tasks, wait until the cavity has cooled to below 50°C / 122°F or use the 'Cool Down' function to cool the cavity.

Contact with cleaning chemicals

▲WARNING

Risk of irritation to skin, eyes and respiratory system.

Direct contact with the cleaning or protective chemicals will irritate the skin, eyes and respiratory system.

- ▷ Do not inhale the vapours or spray mist from the cleaning and protective chemicals.
- ▷ Do not let the cleaning or protective chemicals come into contact with skin, eyes or mucous membranes.
- ▷ Do not spray cleaning or protective chemicals into a cavity.
- ▷ Wear personal protective equipment.

9.5 Cleaning procedures

Cleaning the microwave combination oven

This section explains how to clean your microwave combination oven.

Contents

This section contains the following topics:

	Page
Cool down procedure before cleaning	97
Cleaning instructions	99

9.5.1 Cool down procedure before cleaning

For your safety when cleaning

Before starting cleaning work, it is essential that you familiarize yourself with the rules and hazard warnings specified in '*Safe working when cleaning*' on page 94, and follow the instructions given there.

Purpose



With the optional 'cool down' function you can cool down the cavity quickly for cleaning your microwave combination oven sooner.

Cooling down the cavity

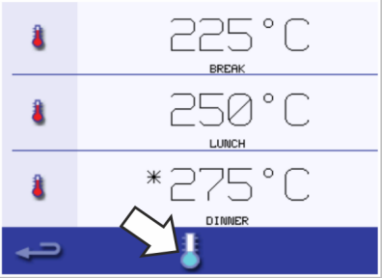
1.  In 'Full Serve mode', select the 'cleaning' symbol from the main menu.

2.  In 'Full' or 'Quick Serve mode', select the 'blue thermometer' symbol to disable heating and to start the cooling cycle. A prompt appears.

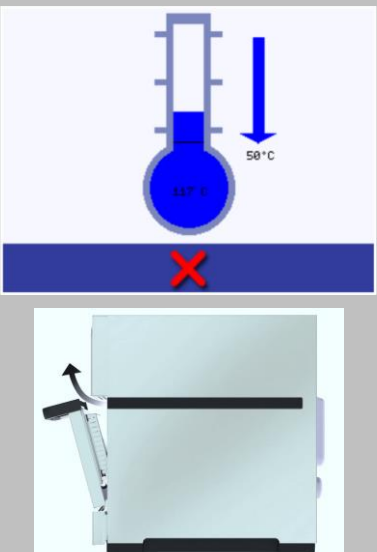

<p>3</p>		<p>Taking all necessary precautions place a suitable tray of ice cubes or cold water into the hot cavity. This speeds up the cooling process.</p> <p>Once the tray of ice is in the oven, press the green tick to continue.</p>
<p>5.</p>		<p>The cooling progress is displayed and takes approximately 20 minutes.</p> <p>To reduce the cool down time, leave the appliance door open slightly during the cooling process.</p>
<p>6.</p>		<p>Once the cooling process is complete, carefully remove the cool down pan from the cavity wearing protective gloves. The pan of water should not be left in the oven overnight or when cold.</p>
<p>7.</p>		<p>The oven is now ready for cleaning and a prompt appears on screen.</p>

9.5.2 Cleaning instructions

⚠ For your safety when cleaning

Before starting cleaning work, it is essential that you familiarize yourself with the rules and hazard warnings specified in 'Safe working when cleaning' on page 94, and follow the instructions listed.



Requirements for cleaning the appliance

- The appliance has been cooled down correctly.
- No food has been left in the cavity.
- All containers, baking sheets, shelf grills and any other accessories have been removed from the cavity.

Cleaning process

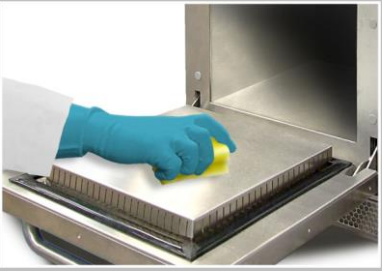

Cleaning oven and oven parts

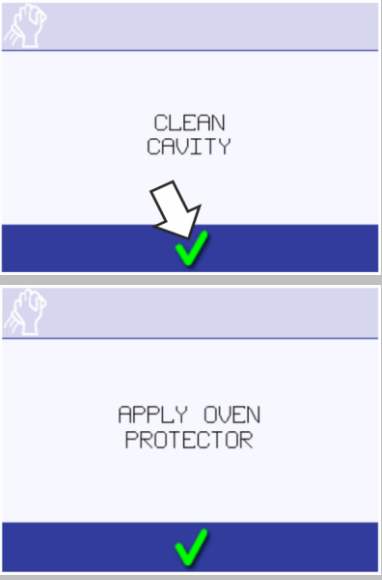
- | | | |
|----|---|--|
| 1. |  | <p>Open the appliance door and remove the cook plate / wire rack and any other cooking accessories from the cavity.</p> <p>NOTE: You can at this stage also remove the air filter to wash it with the other parts (see steps 12-13 for instructions on how to remove the air filter) or you can remove and clean the air filter later (steps 12-17).</p> <p>CAUTION: Wear protective glasses and protective rubber gloves during the cleaning procedure.</p> |
| 2. | | <p>Wash all removed oven parts in warm soapy water.
Wash off using a clean cloth and plenty of clean, warm water.
Dry all components using a fresh, clean cloth.</p> |
| 3. |  | <p>Remove any spillages with suitable cloth or paper towel.
Use a dry clean brush to remove any food particles from between the cavity floor and the inside of the front door.</p> |
| 4. |  | <p>Carefully spray cleaning chemical approved by Merrychef onto a sponge.</p> <p>Clean all surfaces of the cavity except the roof (jet plate) and door seal.</p> <p>NOTICE:
Do not spray directly into the cavity.
Do not clean the roof of the cavity.
Do not use cleaning chemicals or oven protector on the cook plate.</p> |

<p>5.</p>		<p>For difficult areas, leave to soak for 10 minutes with the appliance door open.</p> <p>Use a non-abrasive nylon scrub pad/sponge to clean all surfaces of the cavity and the inside surface of the appliance door.</p> <p>NOTICE: Do not scrub the roof (jet plate) or door seal or use metallic scourers.</p>
<p>6.</p>		<p>Wash off all surfaces using a wet, clean cloth.</p> <p>Dry using a fresh, clean cloth or paper towel.</p> <p>If required the cavity roof and door seal can be wiped clean with a wet clean cloth as well.</p>
<p>7.</p>		<p>Press the green tick to confirm the cavity has been cleaned.</p> <p>You will be prompted to apply protective chemical (oven protector).</p> <p>NOTE: The application of protective chemical is optional but recommended to make cleaning easier the next day.</p> <p>Follow steps 8-11 below to apply oven protector</p> <p style="text-align: center;">or</p> <p>Press the second green tick to skip applying the protective chemical, replace the cook plate and any other parts removed for cleaning and go to step 12 to complete the remaining cleaning procedures.</p>

Applying the protective chemical (optional)

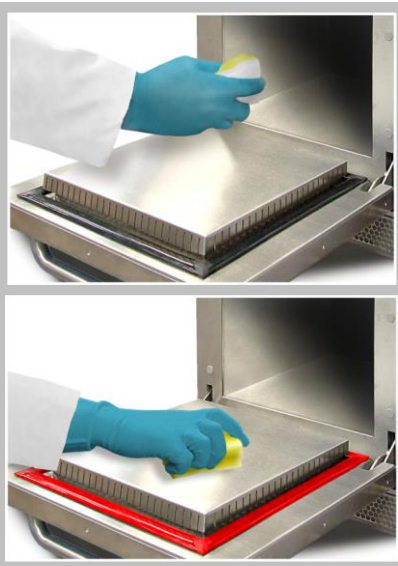
<p>8.</p>		<p>Spray protective chemical approved by Merrychef onto a clean sponge.</p> <p>NOTICE: Only apply the protective chemical to a clean appliance. Ensure protector is only wiped on cavity metal surfaces Ensure the oven is heated before putting cook plate in.</p>
-----------	---	--

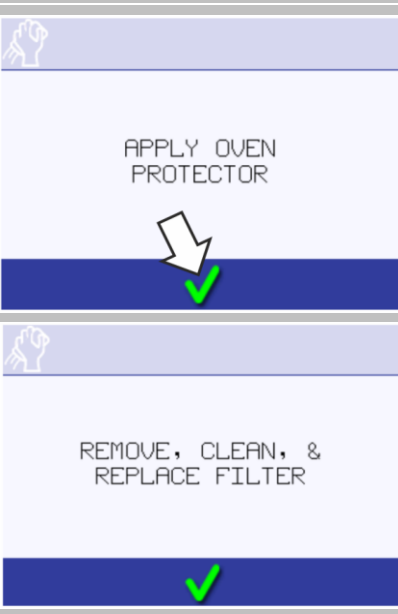
<p>9.</p>		<p>Spread the protective chemical lightly onto all internal surfaces of the appliance avoiding the roof (jet plate) and door seal (marked in red).</p>
<p>10.</p>		<p>Close the appliance door.</p>
<p>11.</p>		<p>Press the green tick to confirm application of the protective chemical.</p> <p>When the green tick is pressed, a prompt appears asking to clean the air filter.</p>

Cleaning the air filter

12.



With the oven door closed, tilt the faceplate below the door downwards.

13.



Remove the air filter by gently pulling it out.

14.

Clean the air filter with a damp cloth or wash it in soapy water and dry it thoroughly.

15.

Replace the air filter and tilt the faceplate in its original position.

16.

Clean the oven exterior with a damp cloth.

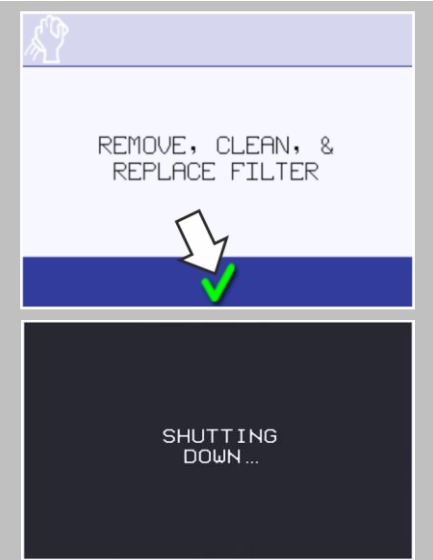

17.



Press the green tick to confirm cleaning of the air filter. The oven switches OFF.

The oven is now ready to be used again if you did not apply protective chemical. If protective chemical was applied, it must be cured, go to step 18.

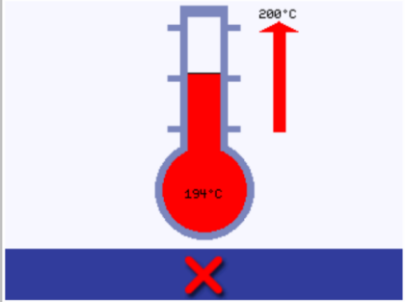
Curing protective chemical

18.		<p>Switch ON the appliance.</p> <p>NOTE: If the air filter has not been replaced the screen will display a warning. Replace the air filter and then press the green tick to continue.</p>
19.		<p>Preheat the cavity.</p> <p>Once reaching the preset operating temperature it will take about 30 minutes to cure the protective chemical, if it was applied.</p> <p>The protective chemical turns light brown when cured.</p>
20.		<p>Replace the cleaned and dried cook plate and any other parts removed for cleaning.</p> <p>Ensure the cook plate / wire rack is fitted on to the cavity support stubs.</p> <p>The oven is now ready again for cooking.</p>

10 Taking the appliance out of operation and disposal

Purpose of this chapter

In this chapter it is explained how to take your microwave combination oven out of operation and dispose of it.

Contents

This chapter contains the following topics:

	Page
Safe working when taking the appliance out of operation	105
Taking the appliance out of operation and disposal	106

10.1 Safe working when taking the appliance out of operation

For your safety when taking the appliance out of operation

Before starting work, familiarize yourself with the hazards described in '*Hazards and safety precautions when taking the appliance out of service*' on page 33.

Eligibility of personnel for taking the appliance out of operation

Work performed on the appliance while taking it out of service is performed in special operating circumstances (e. g. with safety covers removed) or includes activities that require personnel to have relevant qualifications and appliance-specific knowledge that exceed the requirements for operating personnel.

The following requirements must be met by personnel:

- They are qualified employees of an authorized service company.
- Personnel have relevant training as a service engineer.
- Personnel have training specific to the appliance.

Personal protective equipment

Wear the personal protective equipment specified in the section '*Personal protective equipment*' on page 37 of the '*For your safety*' on page 14 chapter for the relevant tasks.

Rules for safe and responsible working when taking the appliance out of operation

Avoid any risks to yourself and others by following the rules below:

- The kitchen floor must always be kept dry to reduce the risk of accidents.
- The appliance door of the microwave combination oven must be closed before disposing of the appliance.
- Don't leave food in the cavity.

Live parts

DANGER

Risk of electric shock from live parts and loose cables

When the safety cover is open, there is a risk of electric shock from touching live parts.

- ▷ Make sure that any work on the electrical system is performed solely by a qualified electrician from an authorized service company.

Moving heavy loads

WARNING

Risk of injury from lifting incorrectly

When lifting the appliance, the weight of the appliance may lead to injuries, especially in the area of the torso.

- ▷ Use a fork-lift truck/pallet truck to move the appliance.
- ▷ When lifting the appliance, use enough people for the weight of the appliance (value depending on age and gender). Observe the local occupational safety regulations.
- ▷ Wear personal protective equipment.

Unsuitable supporting surface

⚠ WARNING

Risk of crushing if the appliance tips over or falls off

Body parts can be crushed if the appliance tips over or falls off.

- ▶ Make sure that the appliance is never placed on an unsuitable supporting surface.

10.2 Taking the appliance out of operation and disposal

Requirements

Before taking the appliance out of service, check that the appliance is de-energized.

Taking the appliance out of operation

To take your appliance out of operation, follow the steps for setting up and installing your appliance in the reverse order (see the chapters '*Installation*' on page 49, '*Moving the appliance*' on page 39 and '*Setting up the appliance*' on page 42).

Do not move the appliance until you have disconnected all the electrical connections.

Disposal

Correct disposal of this product (Waste Electrical & Electronic Equipment)

Applicable in the European Union and other European countries with separate collection systems.



This marking shown on the product or its literature indicates that it must not be disposed with other household wastes at the end of its working life. To prevent possible harm to the environment or human health from uncontrolled waste disposal, please separate this from other types of wastes and recycle it responsibly to promote the sustainable reuse of material resources.

Household users should contact either the retailer where they purchased this product, or their local government office for details of where and how they can take this item for environmentally safe recycling.

Business users should contact their supplier and check the terms and conditions of the purchase contract. This product must not be mixed with other commercial wastes for disposal.

11 Technical data

Purpose of this chapter

This chapter contains the technical data for your microwave combination oven.

Contents

This chapter contains the following topics:

	Page
Technical data	108
Dimensional drawings	110

11.1 Technical data

Dimensions and weights

Width				
Including packaging	[in]	21.1	[mm]	535
Appliance without packaging	[in]	14.0	[mm]	356
Height				
Including packaging	[in]	33.5	[mm]	850
Appliance ("Classic" exterior) without packaging	[in]	24.4	[mm]	620
Appliance ("Trend" exterior) without packaging	[in]	25.4	[mm]	644
Depth				
Including packaging	[in]	35.3	[mm]	895
Appliance without packaging, door closed	[in]	25.0	[mm]	636
Weight				
High Power version, including packaging	[lbs]	155	[kg]	70.4
High Power version, excluding packaging	[lbs]	134	[kg]	61.0
Standard Power version, including packaging	[lbs]	135	[kg]	61.1
Standard Power version, excluding packaging	[lbs]	114	[kg]	51.7
Safety clearances				
Rear / right / left	[in]	0	[mm]	0
Top (for ventilation)	[in]	2	[mm]	50

Electrical connected load ratings – High Power version

Electrical supply	1N~ 220-230V 50Hz	2N~ 380-400V 50Hz	1N~ 220V 60Hz	2~ 200V 50/60Hz
Connections used	L + N + E	L1 + L2 + N + E	L + N + E	2P + GND
Arrangement	Single Phase	Twin Phase	Single Phase	Two Pole
Rated power consumption	[W] 6000	2500 + 3300	6000	6000
Rated current per phase	[A] 32	16 / 32	32	32
Power output				
Rated power output convected heat	[W] 2200	2200	2200	2000
Rated power output microwave (IEC 705) 100%	[W] 2000	2000	2000	2000
Rated power output combination mode	[W] 2200 + 2000	2200 + 2000	2200 + 2000	2000 + 2000

Electrical connected load ratings – Standard Power version

Electrical supply		1N~ 220-230V 50Hz	1N~ 220-230V 50Hz	1N~ 220V 60Hz
Connections used		L + N + E	L + N + E	L + N + E
Arrangement		Single Phase	Single Phase	Single Phase
Rated power consumption	[W]	2990	3680	2860
Rated current per phase	[A]	13	16	13
Power output				
Rated power output convected heat	[W]	2200	2200	2200
Rated power output microwave (IEC 705) 100%	[W]	1000	1000	1000
Rated power output combination mode (convected heat + microwave)	[W]	900 + 1000	1300 + 1000	900 + 1000

Regulatory standards compliance

Degree of protection	IPX0
Noise emission	max. 70 [dBA]
Approval marks	
Tested safety	CE, CB (IEC)
Hygiene	UL-EPH (NSF/ANSI 4)

11.2 Dimensional drawings

eikon e2s

Front view (door closed)

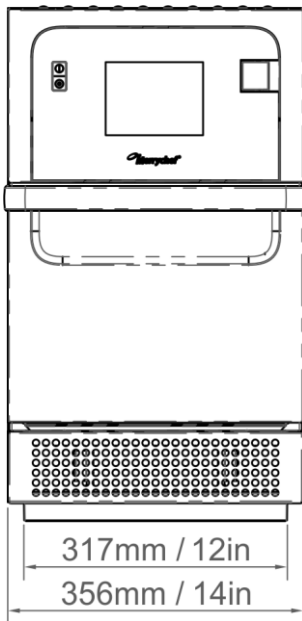

Cavity dimensions (door closed)

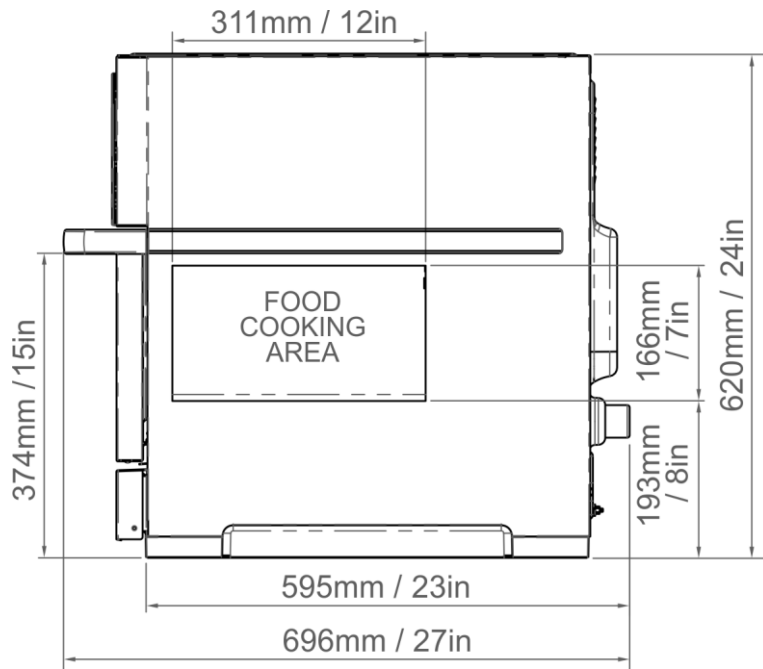

View from the top (door closed)

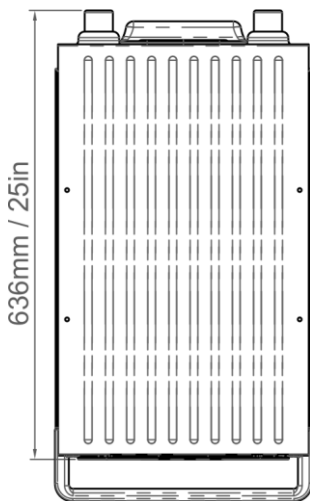

View from the right hand side (door open)

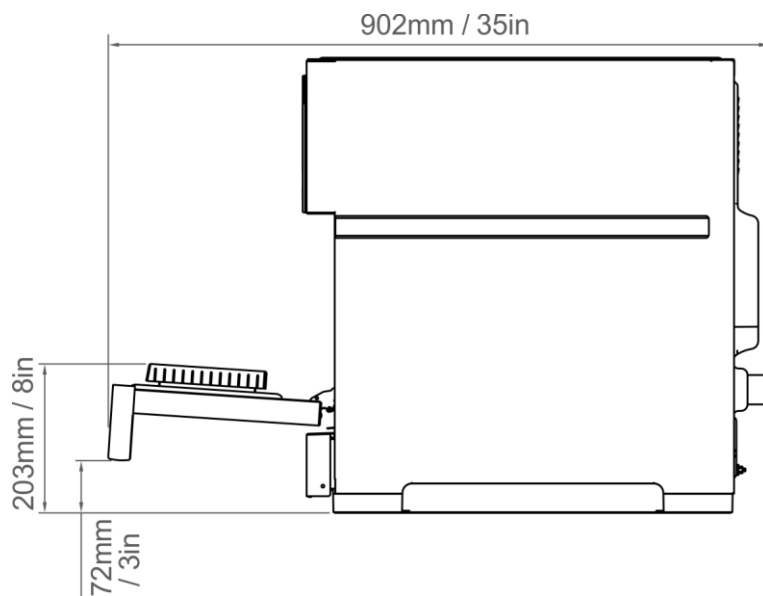

12 Servicing information

Purpose of this chapter

This chapter informs about the correct procedure to follow during servicing and summarizes possible faults with the appliance and errors that may arise during operation.

Contents

This chapter contains the following topics:

	Page
Warranty information and contacting customer service	112
Rectifying faults: problems in operation	113

12.1 Warranty information and contacting customer service

Warranty information

In order to be able to claim under the warranty for the microwave combination oven, the appliance must be installed in accordance with the instructions in the Installation and User Manual by a qualified service engineer from an authorized service company.

The warranty does not cover damage resulting from improper setup, installation, use, cleaning, use of cleaning chemicals, servicing or repair.

Required information

Please have the following appliance data to hand when contacting our customer service:

- Part number of your appliance (see '*Identifying your microwave combination oven*' on page 8)
- Serial number of your appliance (see '*Identifying your microwave combination oven*' on page 8)

Contact data

Welbilt UK Ltd.
Ashbourne House, The Guildway,
Old Portsmouth Road
Guildford, GU3 1LR
United Kingdom

Reception

Phone (head office)	(+44) (0) 1483 464900
---------------------	-----------------------

Fax	(+44) (0) 1483 464905
-----	-----------------------

Internet	www.merrychef.com www.welbilt.com
-----------------	--

12.2 Rectifying faults: problems in operation

Fault finding chart

Although every effort is made to ensure your oven will continue to perform to a high standard, please check the chart to see if the problem can be easily resolved before contacting your service agent.

Problem	Possible cause	Remedy
The appliance does not work and the display screen is blank	The appliance has no power	<ul style="list-style-type: none"> ▪ Check if there is a power cut. ▪ Check if the isolator switch is ON or the appliance is plugged in correctly. ▪ Check if the appliance switch is ON.
Some screen controls do not work	Unauthorised access	Contact an authorised user.
Display shows a warning message	Details are shown on screen	Follow the instructions displayed.
The appliance does not cook the food correctly	<ul style="list-style-type: none"> ▪ Appliance is not clean ▪ Food not at correct temperature ▪ Modified or wrong program selected ▪ Food wrapped ▪ Food removed early 	<ul style="list-style-type: none"> ▪ Clean the appliance (see '<i>Cleaning Instructions</i>' on page 99) ▪ Use the correct cooking program. ▪ Unwrap food. ▪ Check if all the cooking stages have been followed correctly.
The appliance does not finish cooking	<ul style="list-style-type: none"> ▪ Warning message displayed ▪ The appliance door is open ▪ No air filter or incorrectly fitted ▪ Overheating of the appliance 	<ul style="list-style-type: none"> ▪ Close the appliance door. ▪ Refit the air filter. ▪ Allow the appliance to cool down. ▪ Check and remove any restrictions around the air vents.
Display shows an error code	Malfunction of the appliance	Note the error code and contact your service agent.



Microwave Combination Oven

Merrychef eikon e2s

Part Number 32Z3923 – CE, GB

Issue 05 – 03/2019

Welbilt is one of the world's largest manufacturers and suppliers of professional gastronomic appliances.
We supply our customers with energy-saving, reliable and market-leading technologies from a single source.

If you want to find out more about Welbilt and its company brands,
please visit us at www.welbilt.com

